

---

# SQL Language Quick Reference

This Reference briefly describes elements of SQL and the ORACLE7 data dictionary. For details on SQL, refer to the *SQL Language Reference Manual*. For information on the data dictionary see the *ORACLE7 Server Administrator's Guide* or the *ORACLE7 Server Application Developer's Guide*. For information on Trusted ORACLE, see the *Trusted ORACLE7 Server Administrator's Guide*.

---

## Index of Major Sections

Functions	3	Privileges	15	Comments	63
Format Models	8	Expressions and	19	Special Tables	64
Pseudocolumns	12	Conditions		Data Dictionary Views	65
Datatypes	12	Operators	22	Dynamic Tables	71
Names and Reserved	13	SQL Commands	24		
Words		Embedded SQL	64		

---

## Index of Commands

ALTER CLUSTER	24	COMMENT	39	CREATE VIEW	54
ALTER DATABASE	24	COMMIT	39	DELETE	54
ALTER FUNCTION	27	CREATE CLUSTER	39	DROP	55
ALTER INDEX	27	CREATE CONTROLFILE	40	EXPLAIN PLAN	57
ALTER PACKAGE	27	CREATE DATABASE	41	GRANT (System Privileges and Roles)	57
ALTER PROCEDURE	27	CREATE DATABASE	41	GRANT (Object Privileges)	57
ALTER PROFILE	27	LINK	42	INSERT	58
ALTER RESOURCE COST	28	CREATE FUNCTION	42	LOCK TABLE	58
ALTER ROLE	28	CREATE INDEX	42	NOAUDIT (SQL Statements)	58
ALTER ROLLBACK SEGMENT	28	CREATE PACKAGE	43	NOAUDIT (Schema Objects)	59
ALTER SEQUENCE	29	CREATE PACKAGE BODY	43	RENAME	59
ALTER SESSION	29	CREATE PROCEDURE	43	REVOKE (System Privileges and Roles)	59
ALTER SNAPSHOT	30	CREATE PROFILE	44	REVOKE (Object Privileges)	59
ALTER SNAPSHOT LOG	31	CREATE ROLE	44	ROLLBACK	60
ALTER SYSTEM	31	CRATE ROLLBACK SEGMENT	45	SAVEPOINT	60
ALTER TABLE	32	CREATE SCHEMA	45	SELECT	60
ALTER TABLESPACE	34	CREATE SEQUENCE	45	SET ROLE	62
ALTER TRIGGER	34	CREATE SNAPSHOT	46	SET TRANSACTION	62
ALTER USER	34	CREATE SNAPSHOT LOG	47	TRUNCATE	63
ANALYZE	35	CREATE SYNONYM	47	UPDATE	63
AUDIT (SQL Statements)	36	CREATE TABLE	48		
AUDIT (Schema Objects)	38	CREATE TABLESPACE	52		
		CREATE TRIGGER	53		
		CREATE USER	53		

---

## Parameters mentioned in this Reference

<i>Parameter</i>	<i>Explanation</i>
c_alias	Column alias. Another name for a column specified in SELECT statement.
char	Column constant in single quotes or expression of datatype CHAR or VARCHAR2.
column_element	Column definition. For the format of a <i>column element</i> refer to the CREATE TABLE statement.
condition	Expression that logically evaluates to TRUE, FALSE, or UNKNOWN.
constraint	The name of an integrity constraint, stored in the data dictionary.
dblink	Database link.

expr	Any expression.
location	Operating-system-dependent specification of a file's location. Usually either a device or a directory.
integer	Number constant or expression of datatype NUMBER. Must evaluate to an integer.
m,n	Any number constant or expression of datatype NUMBER.
'nls_sort'	An expression of the form 'NLS_SORT = name', where name is either BINARY or the name of a linguistic sort sequence
subquery	Query expression in another statement, such as CREATE TABLE---AS <i>subquery</i>
rowid	Expression of datatype ROWID>
t_alias	Table alias. Another name for a table specified in a SELECT statement
scn	System Change Number. A number that uniquely identifies a transaction.
sid,serial#	Session ID and serial number. A combination that uniquely identified a session.

---

## Functions

### Single-Row Number Functions

<b>Functions</b>	<b>Value Returned</b>
<b>ABS(<i>n</i>)</b>	Absolute value of <i>n</i> .
<b>CEIL(<i>n</i>)</b>	Smallest integer greater than or equal to <i>n</i> .99
<b>COS(<i>n</i>)</b>	Cosine of <i>n</i> in radians.
<b>COSH(<i>n</i>)</b>	Hyperbolic cosine of <i>n</i> in radians..
<b>EXP(<i>n</i>)</b>	<i>e</i> raised to the <i>n</i> th power.
<b>FLOOR(<i>n</i>)</b>	Largest integer equal to or less than <i>n</i> .
<b>LN(<i>n</i>)</b>	Natural logarithm of <i>n</i> , where <i>n</i> > 0
<b>LOG(<i>m</i>,<i>n</i>)</b>	Logarithm, base <i>m</i> , of <i>n</i> .
<b>MOD(<i>m</i>,<i>n</i>)</b>	Remainder of <i>m</i> divided by <i>n</i> .
<b>POWER(<i>m</i>,<i>n</i>)</b>	<MI%-2> <i>m</i> raised to the <i>n</i> th power.<%0>
<b>ROUND(<i>n</i>[,<i>m</i>])</b>	<i>n</i> rounded to <i>m</i> decimal places; <i>m</i> defaults to 0.
<b>SIGN(<i>n</i>)</b>	If <i>n</i> <0, -1; if <i>n</i> =0, 0; if <i>n</i> >0, 1.
<b>SIN(<i>n</i>)</b>	Sine of <i>n</i> in radians.

<b>SINH</b> (n)	Hyperbolic sine of <i>n</i> in radians.
<b>SQRT</b> (n)	Square root of <i>n</i> ; if <i>n</i> <0, NULL.
<b>TAN</b> (n)	Tangent of <i>n</i> in radians.
<b>TANH</b> (n)	Hyperbolic tangent of <i>n</i> in radians.
<b>TRUNC</b> (n[,m])	<MI%-2>n truncated to <i>m</i> decimal places; <i>m</i> defaults to 0.<%0>

## Single-Row Character Functions

Single row character functions that return character values:

<b>Function</b>	<b>Value Returned</b>
<b>CHR</b> (n)	CharacDate of the first day of the week named by char that is equal to or later than the date d.
<b>CONCAT</b> (char1,char2)	Concatenates char1 and char2.
<b>INITCAP</b> (char)	char, with first letter of each word capitalized.
<b>LOWER</b> (char)	char, with all letters lowercase.
<b>LPAD</b> (char1,n[,char2])	char1, left-padded to length n with the sequence of characters in char2; char2 defaults to ". A multi-byte character that does not fit is replaced with a blank.
<b>LTRIM</b> (char[,set])	char, with initial characters removed up to the first character not in set. set defaults to ' '.
<b>NLS_INITCAP</b> (n [, nls_sort])	char, with first letter of each word capitalized. nls_sort defines handling of language-specific capitalization.
<b>NLS_LOWER</b> (n [, nls_sort])	char, with all letters lowercase. nls_sort defines handling of language-specific capitalization.
<b>NLS_UPPER</b> (n [, nls_sort])	char, with all letters uppercase. nls_sort defines handling of language-specific capitalization.
<b>REPLACE</b> (char,search_string [,replacement_string])	char, with every occurrence of search_string replaced by replacement_string. If you do not specify replacement_string, ORACLE removes all occurrences of search_string.
<b>RPAD</b> (char1,n[,char2])	char1, right-padded to length n with the sequence of characters in char2; char2 defaults to a blank. A multi-byte character that does not fit is replaced with a blank.

<b>RTRIM</b> ( <i>char</i> [, <i>set</i> ])	<i>char</i> , with final characters removed after the last character not in <i>set</i> . <i>set</i> defaults to ' '.
<b>SOUNDEX</b> ( <i>char</i> )	A <i>char</i> value representing the sound of the word(s) in <i>char</i> .
<b>SUBSTR</b> ( <i>char</i> , <i>m</i> [, <i>n</i> ])	A substring of <i>char</i> , beginning at character <i>m</i> , <i>n</i> characters long (if <i>n</i> is omitted, to end of <i>char</i> ).
<b>SUBSTRB</b> ( <i>char</i> , <i>m</i> [, <i>n</i> ])	A substring of <i>char</i> , beginning at byte <i>m</i> , <i>n</i> bytes long (if <i>n</i> is omitted, to end of <i>char</i> ).
<b>TRANSLATE</b> ( <i>char</i> , <i>from</i> , <i>to</i> )	<i>char</i> , translated from the character set <i>from</i> to the character set <i>to</i> .
<b>UPPER</b> ( <i>char</i> )	<i>char</i> , with all letters uppercase.

Single row character functions that return character values:

<b>Function</b>	<b>Value Returned</b>
<b>ASCII</b> ( <i>char</i> )	Returns a decimal number equivalent to the value of the first character of <i>char</i> in the database character set. (An ASCII value on ASCII systems.) Returns value of first byte in a multi-byte character.
<b>INSTR</b> ( <i>char1</i> , <i>char2</i> [, <i>n</i> [, <i>m</i> ]])	Position of the <i>m</i> th occurrence of <i>char2</i> in <i>char1</i> , beginning search at character position <i>n</i> . <i>m</i> and <i>n</i> default to 1. Position is relative to the first character of <i>char1</i> , even if <i>n</i> >1.
<b>INSTRB</b> ( <i>char1</i> , <i>char2</i> [, <i>n</i> [, <i>m</i> ]])	Position of the <i>m</i> th occurrence of <i>char2</i> in <i>char1</i> , beginning search at byte position <i>n</i> . <i>m</i> and <i>n</i> default to 1. Position is relative to the first byte of <i>char1</i> , even if <i>n</i> >1.
<b>LENGTH</b> ( <i>char</i> )	Length of <i>char</i> in characters
<b>LENGTHB</b> ( <i>char</i> )	Length of <i>char</i> in bytes
<b>NLSSORT</b> ( <i>char</i> )	The NLS-equivalent value used when sorting <i>char</i> .

### Group Functions

<b>Function</b>	<b>Value Returned</b>
<b>AVG</b> ([ <b>DISTINCT</b>   <b>ALL</b> ] <i>n</i> )	Average value of <i>n</i> , ignoring nulls.
<b>COUNT</b> ([ <b>ALL</b> ]*)	Number of rows returned by a query or subquery.
<b>COUNT</b> ([ <b>DISTINCT</b>   <b>ALL</b> ] <i>expr</i> )	Number of rows where <i>expr</i> is not null.
<b>MAX</b> ([ <b>DISTINCT</b>   <b>ALL</b> ] <i>expr</i> )	Maximum value of <i>expr</i> .
<b>MIN</b> ([ <b>DISTINCT</b>   <b>ALL</b> ] <i>expr</i> )	Minimum value of <i>expr</i> .

<b>STDDEV</b> ( <b>[DISTINCT   ALL]</b> <i>n</i> )	Standard deviation of <i>n</i> , ignoring null values.
<b>SUM</b> ( <b>[DISTINCT   ALL]</b> <i>n</i> )	Sum values of <i>n</i> .
<b>VARIANCE</b> ( <b>[DISTINCT   ALL]</b> <i>n</i> )	Variance of <i>n</i> , ignoring null values.

## Date Functions

<b>Function</b>	<b>Value Returned</b>
<b>ADD_MONTHS</b> ( <i>d,n</i> )	Date <i>d</i> plus <i>n</i> months.
<b>LAST_DAY</b> ( <i>d</i> )	Date of last day of month containing <i>d</i> .
<b>MONTHS_BETWEEN</b> ( <i>d,e</i> )	<%-2>Number of months by which <i>e</i> precedes <i>d</i> .<%0>
<b>NEW_TIME</b> ( <i>d,a,b</i> )	Date and time in time zone <i>b</i> when date and time in time zone <i>a</i> are <i>d</i> . <i>a</i> and <i>b</i> are CHAR values identifying time zones.
<b>NEXT_DAY</b> ( <i>d,char</i> )	Date of the first day of the week named by <i>char</i> that is equal to or later than the date <i>d</i> .
<b>SYSDATE</b>	Current date and time.

## Date Truncation and Rounding

<b>Function</b>	<b>Value Returned</b>
<b>ROUND</b> ( <i>d[,fmt]</i> )	<i>d</i> rounded as specified by rounding unit <i>fmt</i> .
<b>TRUNC</b> ( <i>d[,fmt]</i> )	<i>d</i> truncated as specified by <i>fmt</i> .

### Format Models for ROUND and TRUNC

This table list the date format elements used to control truncation and rounding. If no format element is specified, *fmt* defaults to 'DD'.

<b>Format Element</b>	<b>Value Returned</b>
<b>CC or SCC</b>	First day of the century
<b>YYYY or SYYYY</b> <b>YYY or YY or Y</b> <b>Y,YYY or YEAR or SYEAR</b>	First day of the year (rounds up on July 1)
<b>Q</b>	First day of the quarter (rounds up on 16th day of 2nd month of the quarter)
<b>MONTH or MON or MM or RM</b>	Same day of the month (rounds up on 16th day)
<b>WW or IW</b>	Same day of the week as Jan 1st of that year

<i>Format Element</i>	<i>Value Returned</i>
W	Same day of the week as the 1st of the month
DDD or DD or J	Day
DAY or DY or D	First day of the week
HH or HH12 or HH24	Hour
MI	Minute

## Conversion Functions

<b>Function</b>	<b><i>Value Returned</i></b>
<b>CHARTORWID(char)</b>	char, converted from a CHAR value to a ROWID value.
<b>CONVERT(char,dest_char_set [,source_char_set])</b>	CHAR, converted from source_char_set representation to dest_char_set representation.
<b>HEXTORAW(char)</b>	char, converted from a hexadecimal number to a binary RAW value.
<b>RAWTHOHEX(raw)</b>	raw, converted from a binary value of data-type RAW to a decimal number of data-type CHAR.
<b>ROWIDTOCHAR9rowid)</b>	rowid, converted from a ROWID value to a CHAR value.
<b>TO_CHAR(expr[,fmt [, 'nls_num_fmt']])</b>	expr, converted from a NUMBER or DATE value to a CHAR value in the format specified by fmt. If you omit fmt, ORACLE converts DATE values to default date format and NUMVWER value3s to CHAR values exactly wide enough to hold all significant digits. nls_num_fmt sets the international number-format specifications. In Trusted ORACLE, convert values of type MLS or MLS_LABEL to type VARCHAR2.
<b>TO_DATE(char[,fmt [, 'nls_lang']])</b>	char, converted from a CHAR value in the format fmt to a DATE value. If you omit fmt, char must be in default date format. nls_lang specifies the language4 used for day and month.
<b>TO_MULTI_BYTE(char)</b>	char, with all single-byte characters that have a multi-byte equivalent converted to their multi-byte form.

<b>TO_NUMBER(char [,fmt [, 'nls_lang']]</b> )	char, which is a character value containing a number in the format specified by the optional <i>fmt</i> , converted to a NUMBER value. <i>nls_lang</i> specifies the language used for numeric characters and currency symbols.
<b>TO_SINGLE_BYTE(char)</b>	char, with all multi-byte characters that have a single-byte equivalent converted to their single-byte form.

## Other Functions

### Function

**DECODE**(*expr*,*search1*,*return1*,  
[*search2*,*return2*,...] [*default*])

**DUMP**(*expr* [, *display\_format*  
[, *start\_position* [, *length*]])

**GREATEST**(*expr* [, *expr*]...)

**LEAST**(*expr* [, *expr*]...)

**NVL**(*expr1*,*expr2*)

**UID**

**USER**

**USERENV**(' *option*')

**VSIZE**(*expr*)

**SYSDATE**

### Value Returned

If *expr* equals any *search*, returns the following *return*; if not, returns *default*.

*expr* in ORACLE internal format.

*expr* with the greatest value.

*expr* with the least value.

*expr2*, if *expr1* is null; otherwise returns *expr1*.

<%-2>Number that uniquely identifies the current user.<%0>

Name of the current user.

Information about the current session. Specify option in single quotes. Options: ENTRYID, SESSIONID, TERMINAL, and LANGUAGE.

The number of bytes in ORACLE's internal representation of *expr*.

Current system time/date.

---

## Format Models

### Date Format Models for TO\_CHAR and TO\_DATE

This table lists the date format elements. You can use any combination of these elements as the *fmt* argument of the TO\_CHAR or TO\_DATE functions. *fmt* defaults to the default DATE format, 'DD-MON-YY'.

**Format Element**

SCC or CC

YYYY or SYYYY

YYY or YY or Y

IYYY

IYY or IY or I

Y,YYY

SYEAR or YEAR

RR

BC or AD

B.C. or A.D.

Q

MM

RM

MONTH

MON

WW or W

IW

DDD or DD or D

DAY

DY

J

AM or PM

A.M. or P.M.

HH or HH12

HH24

MI

SS or SSSSS

-/,,:;

"...text..."

**Value Returned**Century; 'S' prefixes BC date with '-'.  
Year; 'S' prefixes BC date with '-'.  
Last 3,2, or 1 digit(s) of year. Century defaults to current.  
4-digit ISO standard year.  
Last 3,2, or 1 digit(s) of ISO year.  
Year with comma in this position.  
Year spelled out; 'S' prefixes BC date with '-'.  
Last 2 digits of year, for years in next century.  
BC/AD indicator.  
BC/AD indicator with periods.  
Quarter of year (1,2,3,4; JAN-MAR=1)  
Month of year (01-12; JAN=01)  
Roman Numeral month (I..XII;JAN=I).  
Month name, padded with blanks to 9 characters.  
Name of month, abbreviated (JAN,FEB,etc.).  
Week of year (1052) or month (1-5)  
ISO standard week of the year (1..21 or 1..53).  
Day of year (1-366) or month (1-31) or week (1-7).  
Name of day, blank-padded to 9 characters.  
Name of day, 3-lettter abbreviation.  
Julian day (days since December 31, 4713 BC).  
Meridian indicator.  
Meridian indicator with periods.  
Hour of the day (1-12).  
Hour of day (0-23).  
Minute (0-59).  
Second (0-59) or seconds past midnight (0-86399).  
Punctuation is reproduced in the result.  
QQuoted string is reproduced in the result.**Date Format Prefixes  
and Suffixes**

You can add this prefix to date format elements:

<b>FM</b>	"Fill mode." Suppresses blank padding when prefixed to MONTH or DAY. FM is a toggle. Use FM twice to reenable blank padding.
<b>FX</b>	"Format exact." Specifies exact matching for the character argument and date format model of a TO_DATE function

You can add this suffixes to date format elements:

<b>TH</b>	Ordinal number ("DDTH" for "4TH").
<b>SP</b>	Spelled-out number ("DDSP" for "FOUR").
<b>SPTH and THSP</b>	Spelled-out ordinal number ("DDSPTH" for "FOURTH"). The following strings specify output in uppercase, initial caps, or lowercase:

### Date Format Case Control

The following strings output in uppercase, initial caps, or lowercase:

<b><i>Uppercase</i></b>	<b><i>Initial Caps</i></b>	<b><i>Lowercase</i></b>
DAY	Day	day
DY	Dy	dy
MONTH	Month	month
MON	Mon	mon
YEAR	Year	year
AM	Am	am
PM	Pm	pm
A.M., A.m.		am
p.m., p.M.		pm

When prefixes or suffices are added to a date format, the case (uppercase, initial caps, or lowercase) is determined by the format element, not by the prefix or suffix. For example, 'ddTH' produces "04th", not "04TH".

**Number Format Models for TO\_CHAR** This table lists the number format elements. You can use a combination of these elements as the *fmt* argument of the TO\_CHAR function.

Format Element	Example	Function
9	9999	Number of "9"s determines length of returned character.
0	'0999'	Prefixes value with leading zeroes.
\$	\$9999	Prefixes value with dollar sign.
B	B9999	Returns zero value as blank, instead of "0".
MI	9999MI	Returns "-" after negative values.
S	S9999	Returns "+" for positive values and "-" for negative values.
PR	9999PR	Returns negative values in <angle brackets>.
D	99D99	Returns the decimal character.
G	9G999	Returns the group separator.
C	C999	Returns the international currency symbol.
L	L999	Returns the local currency symbol.
,	9,999	Returns a comma in this position.
.	99.99	Returns a period in this position.
V	999V99	Multiplies value by 10 <sup>n</sup> , where <i>n</i> is the number of "9"s after the "V".
EEEE	9.999EEEE	Returns value in scientific notation. fmt must contain exactly for "E"s.
RN or rn	RN	upper- or lower-case Roman numerals (numbers in range 1..3999).
DATE	'DATE'	Returns value converted from Julian date to 'MM/DD/YY' date format.

## NLS Parameters

Since the parameters are specified inside a quoted string, the parameter values must be specified with two single quotes, instead of one.

**nls\_num\_fmt ::=**

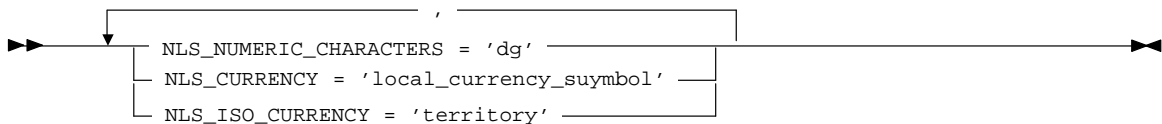

where

**d = decimal character**

**g = group separator**

**nls\_lang ::=**

▶▶ NLS\_DATE\_LANGUAGE = language ◀◀

**nls\_sort ::=**

▶▶ NLS\_SORT = sort ◀◀

Language-specific sort sequence

---

## Pseudo-Columns

Pseudo-columns are similar to table columns. You can query any of these pseudo-columns, but you cannot change their values with DML statements:

<b>Column Name</b>	<b>Value</b>
<i>sequence</i> .CURRVAL	Current value of <i>sequence</i> for the current session. ( <i>sequence</i> .NEXTVAL must be referenced first.)
<i>sequence</i> .NEXTVAL	Next value of <i>sequence</i> for the current session.
<i>table</i> .LEVEL	1 for a root node, 2 for a child of a root, etc. Used in the SELECT statement during tree-structured queries.
[ <i>table</i> .]ROWID	Value that uniquely identifies a single row among other rows in the table. ROWID values are of datatype ROWID, not NUMBER or CHAR.
ROWNUM	Position of a single row among other rows selected by a query. ORACLE selects rows in an arbitrary order and evaluates ROWNUM before sorting rows for an ORDER BY clause.

---

## Datatypes

ORACLE accepts the following datatypes:

<b>CHAR(size)</b>	Fixed length character string of <i>size</i> characters. Default 1. Maximum 255.
<b>CHARACTER(size)</b>	Same as CHAR
<b>DATE</b>	Dates ranging from January 1, 4712 BC to December 31, 4712 AD.
<b>LONG</b>	Variable length character string of up to 2 gigabytes.
<b>LONG RAW</b>	Binary data of up to 2 gigabytes, or 2 <sup>31</sup> - 1.

<b>NUMBER(<i>p,s</i>)</b>	Number having precision <i>p</i> and scale <i>s</i> . <i>p</i> ranges from 1 to 38. Default is 38. <i>s</i> ranges from -84 to 127.
<b>RAW(<i>size</i>)</b>	Binary data of up to <i>size</i> bytes. Maximum 2000 bytes. <i>Size</i> must be specified.
<b>ROWID</b>	Values from the pseudo-column ROWID.
<b>VARCHAR2(<i>size</i>)</b>	Variable length character string having maximum length of <i>size</i> . Maximum 2,000. Default 1.
<b>VARCHAR(<i>size</i>)</b>	Same as VARCHAR2.

---

## Names and Reserved Words

<b>Names</b>	<p>Names of database objects</p> <ul style="list-style-type: none"> <li>• are between 1 and 30 characters long, except for database names, which can be no longer than 8 characters</li> <li>• do not contain quotation marks</li> <li>• do not duplicate the name of another object</li> </ul> <p>Names that are always enclosed in double quotation marks can ignore the following rules. Otherwise, names</p> <ul style="list-style-type: none"> <li>• begin with a letter A-Z</li> <li>• contain only the characters A-Z, 0-9, \$, #, and _</li> <li>• do not duplicate a SQL reserved word</li> </ul> <p>Only names that are enclosed in double quotes are case sensitive. All other names are case insensitive.</p>
<b>SQL Reserved Words</b>	<p>SQL reserved words have special meanings in SQL statements. You may not use these words as names for database objects: (Words marked with * are also reserved PL/SQL.)</p>

ACCESS*	DEFAULT*	INTEGER	OPTION*	START*
ADD*	DELETE*	INTERSECT*	OR*	SUCCESSFUL
ALL*	DESC*	INTO*	ORDER*	SYNONYM
ALTER*	DISTINCT*	IS*	PCTFREE*	SYSDATE
AND*	DROP*	LEVEL*	PRIOR*	TABLE*
ANY*	ELSE*	LIKE*	PRIVILEGES	THEN*
AS*	EXCLUSIVE	LOCK	PUBLIC*	TO*
ASC*	EXISTS*	LONG	RAW	TRIGGER
AUDIT	FILE	MAXEXTENTS	RENAME*	UID
BETWEEN*	FLOAT	MINUS*	RESOURCE*	UNION*
BY*	FOR*	MODE	REVOKE	UNIQUE*
CHAR*	FROM*	MODIFY	ROW	UPDATE*
CHECK*	GRANT*	NOAUDIT	ROWID	USER
CLUSTER*	GROUP*	NOCOMPRESS*	ROWLABEL	VALIDATE
COLUMN	HAVING*	NOT*	ROWNUM*	VALUES*
COMMENT	IDENTIFIED*	NOWAIT	ROWS	VARCHAR*
COMPRESS*	IMMEDIATE	NULL*	SELECT*	VARCHAR2*
CONNECT*	IN*	NUMBER*	SESSION	VIEW*
CREATE*	INCREMENT	OF*	SET*	WHENEVER
CURRENT*	INDEX*	OFFLINE	SHARE	WHERE*
DATE*	INITIAL	ON*	SIZE*	WITH*
DECIMAL	INSERT	ONLINE	SMALLINT	

## PL/SQL Reserved Words

ABORT	CREATE	GOTO	PACKAGE	SUM
ACCEPT	CURRENT	GRANT	PARTITION'	TABAUTH
ACCESS	CURSOR	GROUP	PCTFREE	TABLE
ADD	DATABASE	HAVING	PRAGMA	TABLES
ALL	DATA_BASE	IDENTIFIED	PRIOR	TASK
ALTER	DATE	IF	PRIVATE	TERMINATE
AND	DBA	IN	PROCEDURE	THEN
ANY	DEBUGOFF	INDEX	PUBLIC	TO
ARRAY	DEBUGON	INDEXES	RAISE	TRUE
AS	DECLARE	INDICATOR	RANGE	TYPE
ASC	DEFAULT	INSERT	RECORD	UNION
ASSERT	DEFINITION	INTERSECT	RELEASE	UNIQUE
ASSIGN	DELAY	INTO	REM	UPDATE
AT	DELETE	IS	RENAME	USE
AUTHORIZA-	DELTA	LEVEL	RESOURCE	VALUES
TION	DESC	LIKE	RETURN	VARCHAR
AVG	DIGITS	LIMITED	REVERSE	VARCHAR2
BEGIN	DISPOSE	LOOP	REVOKE	VARIANCE
BETWEEN	DISTINCT	MAX	ROLLBACK	VIEW
BODY	DO	MIN	ROWNUM	VIEWS
BOOLEAN	DROP	MINUS	ROWTYPE	WHEN
BY	ELSE	MOD	RUN	WHERE
CASE	ELSIF	NEW	SAVEPOINT	WHILE
CHAR	END	NOCOMPRESS	WSHEMA	WITH
CHAR_BASE	ENTRY	NOT	SELECT	WORK
CHECK	EXCEPTION	NULL	SEPARATE	XOR
CLOSE	EXCEP-	NUMBER	SET	
CLUSTER	TION_INIT	NUMBER_BASE	SIZE	
CLUSTERS	EXISTS	OR	SPACE	
COLAUTH	EXIT	ON	SQL	
COLUMNS	FALSE	OPEN	SQLCODE	
COMMIT	FETCH	OPTION	SQLERRM	
COMPRESS	FOR	OR	START	
CONNECT	FORM	ORDER	STATEMENT	
CONSTANT	FROM	OTHERS	STDDEV	
COUNT	FUNCTION	OUT	SUBTYPE	
CRASH	GENERIC			

---

## Privileges

### System Privileges

These privileges apply to a whole class of objects.

ANALYZE ANY	Analyze any table, index, or cluster in any schema.
AUDIT ANY	Audit any object in any schema.

TRUNCATE ANY	Truncate any table or cluster in any schema.
CREATE <b>CLUSTER</b>	Create a cluster in own schema.
ALTER ANY CLUSTER	Alter any cluster in any schema.
CREATE ANT CLUSTER	Create a cluster in own schema.
DROP ANY CLUSTER	<b>Drop any cluster in any schema.</b>
ALTER <b>DATABASE</b>	Alter the database.
CREATE <b>DATABASE LINK</b>	<b>Create private database links in own schema.</b>
CREATE PUBLIC DATABASE LINK	Create public database links.
DROP PUBLIC DATABASE LINK	Drop public database links.
CREATE <b>INDEX</b>	Create index in own schema on any table in the same schema.
ALTER ANY INDEX	Alter any index in any schema.
CREATE ANY INDEX	Create an index in any schedma on any table in the same schema.
DROP ANY INDEX	Drop any index in any schema.
CREATE <b>PROCEDURE</b>	Create stored procedures, functions, and p[ackages in own schema.
ALTER ANY PROCEDURE	Alter any stored procedure, function, or package in any schema.
CREATE ANY PROCEDURE	Create store procedures, functions, and packages in any schema.
DROP ANY PROCEDURE	Drop stored procedures, functions, and packages in any schema.
EXECUTE ANY PROCEDURE	Execute any stored procedure, function, or package, or reference any public package variable in any schema.
GRANT ANY <b>PRIVILEGE</b>	Grant system privileges even if not currently owned.
ALTER <b>PROFILE</b>	Alter any profile in the database.
CEATE PROFILE	Create profiles
DROP PROFILE	Drop any profile in the database.
ALTER <b>RESOURCE COST</b>	Set costs for sesssion resources
CREATE <b>ROLE</b>	Create roles.
ALTER ANY ROLE	Alter any role in the database.
DROP ANY ROLE	Drop any role in the database.
GRANT ANY ROLE	Grant any role in the database.

<b>ALTER ROLLBACK SEGMENT</b>	Alter rollback segments.
<b>CREATE ROLLBACK SEGMENT</b>	Create rollback segments.
<b>DROP ROLLBACK SEGMENT</b>	Drop rollback segments.
<b>ALTER SESSION</b>	Trace facility, national language characteristics, close a database link.
<b>CREATE SESSION</b>	Connects the database.
<b>RESTRICTED SESSION</b>	Logon after the database is started using <b>STARTUP RESTRICT</b> .
<b>CREATE SEQUENCE</b>	Create a sequence in own schema.
<b>ALTER ANY SEQUENCE</b>	Alter any sequence in any schema.
<b>CREATE ANY SEQUENCE</b>	Create a sequence in any shcema.
<b>DROP ANY SEQUENCE</b>	Drop any sequence in any schema.
<b>SELECT ANY SEQUENCE</b>	Reference any sequence in any schema.
<b>CREATE SNAPSHOT</b>	Create snapshots in any schema. Requires <b>CREAE ANY TABLE</b> , as well.
<b>ALTER ANY SNAPSHOT</b>	Alter any snapshot in the schema.
<b>CREATE ANY SNAPSHOT</b>	Create cnapshts in any schema. Requires <b>CREATE ANY TABLE</b> , as well.
<b>DROP ANY SNAPSHOT</b>	Drop any snapshot in any schema.
<b>CREATE SYNONYM</b>	Create a synonym in won schema.
<b>CREATE ANY SYNONYM</b>	Create a synonym in any schema.
<b>DROP ANY SYNONYM</b>	Drop any synonym in any schema, except public synonyms.
<b>CREATE PUBLIC SYNONYM</b>	Create public synonyms.
<b>DROP PUBLIC SYNONYM</b>	Drop public synonyms.
<b>AUDIT SYSTEM</b>	Audit system events.
<b>ALTER SYSTEM</b>	resource limits, server and dispatcher processes, change and archive redo log files, distriburtd recovery, checkpoint, verify file access.
<b>CREATE TABLE</b>	Create tables in own schema. Requires <b>UNLIMITED TABLESPACE</b> , or a quota on a tablespace.
<b>ALTER ANY TABLE</b>	Alter any table in any schema.
<b>BACKUP ANY TABLE</b>	Backup any table in any schema with <b>ALTER TABLE</b> command.
<b>COMMENT ANY TABLE</b>	Comment on any table, view, or column in any schema.
<b>CREATE ANY TABLE</b>	Create a table in any schema.

DELETE ANY TABLE	Delete rows from any table, view, or snapshot in any schema.
DROP ANY TABLE	Drop any table in any schema.
INSERT ANY TABLE	insert into any table, view, or snapshot in any schema.
LOCK ANY TABLE	Lock any table in any schema.
SELECT ANY TABLE	Query any table, view, or snapshot in any schema.
UPDATE ANY TABLE	Update rows in any table, view, or snapshot in any schema.
ALTER TABLESPACE	Alter tablespaces.
CREATE TABLESPACE	Create tablespaces.
DROP TABLESPACE	Drop tablespaces.
MANAGE TABLESPACE	Tablespace online and offline. Tablespace backups.
UNLIMITED TABLESPACE	Use an unlimited amount of any tablespace.
FORCE TRANSACTION	Force commit or rollback of own distributed transaction in the local database.
FORCE ANY TRANSACTION	Force commit or rollback of any distributed transaction in the local database.
CREATE TRIGGER	Create triggers in own schema.
ALTER ANY TRIGGER	Enable, disable, or compile trigger in any schema.
CREATE ANY TRIGGER	Create a trigger in any schema associated with any table in any schema.
DROP ANY TRIGGER	Drop any trigger in any schema.
ALTER USER	Alter other users: password, authentication method, quotas, tablespaces, assign a profile & default roles
BECOME USER	Become another user.
CREATE USER	Create users, assign quotas on any tablespace, set default and temporary tablespaces, assign a profile.
DROP USER	Drop another user.
CREATE VIEW	Create a view in own schema
CREATE ANY VIEW	Create a view in any schema.
DROP ANY VIEW	Drop any view in any schema.

## Object Privileges

These privileges apply to specific objects.

### *Object Privilege*

### *Explanation*

ALL	All of the object privileges that can be applied.
ALL PRIVILEGES	Same as ALL.

ALTER	Change definition.
DELETE	Delete rows.
EXECUTE	Execute the object, reference its variables.
INDEX	Create an index on the table.
INSERT	Insert rows.
REFERENCES	Create a constraint that refers to the table. Not granted to roles.
SELECT	Query rows.
UPDATE	Change rows.

Object Privilege	Procedure Functions				
	Table	Views	Sequences	Packages	Snaphots
ALTER	√		√		
DELETE	√	√			
EXECUTE				√	
INDEX	√				
INSERT	√	√			
REFERENCES	√	√			
SELECT	√	√	√		√
UPDATE	√	√			

---

## Expressions and Conditions

The following diagrams show the possible expressions and conditions denoted by "expr" and "condition" in the SQL command syntax diagrams.

**expr ::=**

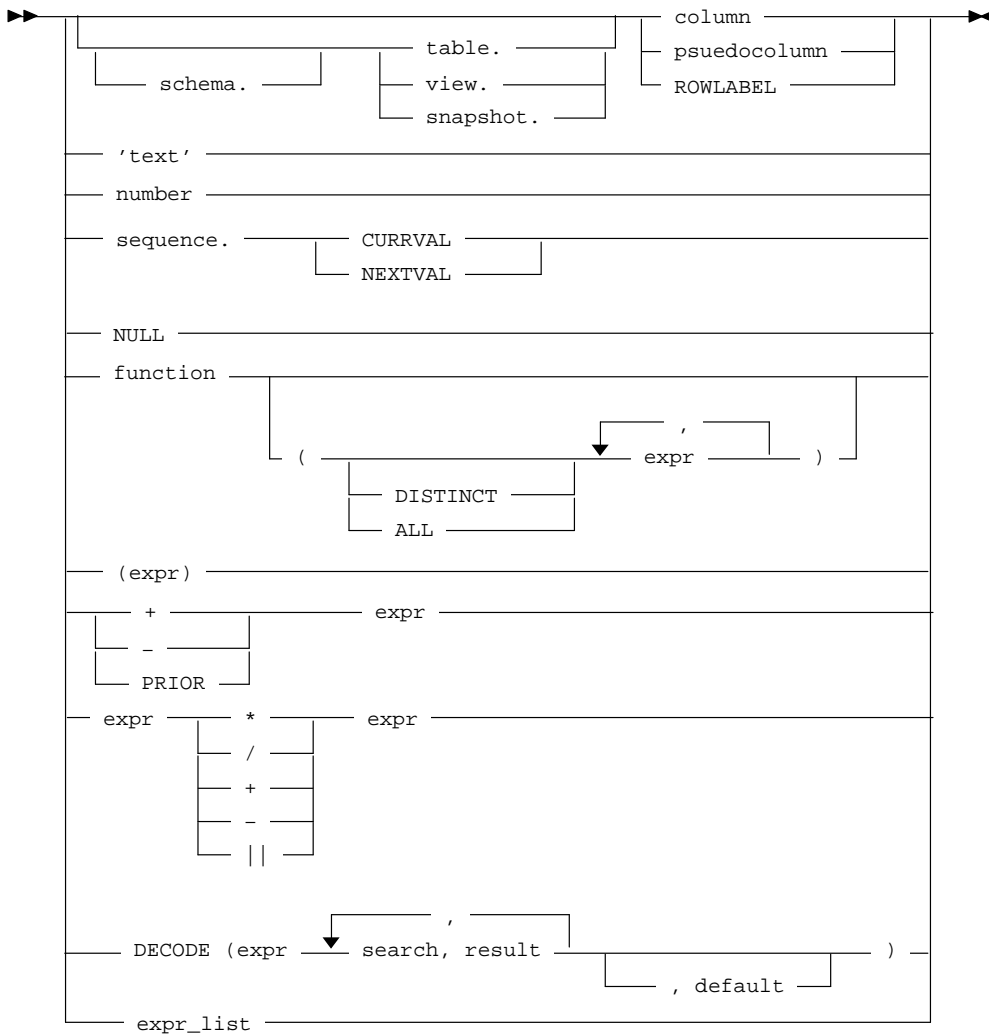

**expr\_list ::=**



**condition ::=**

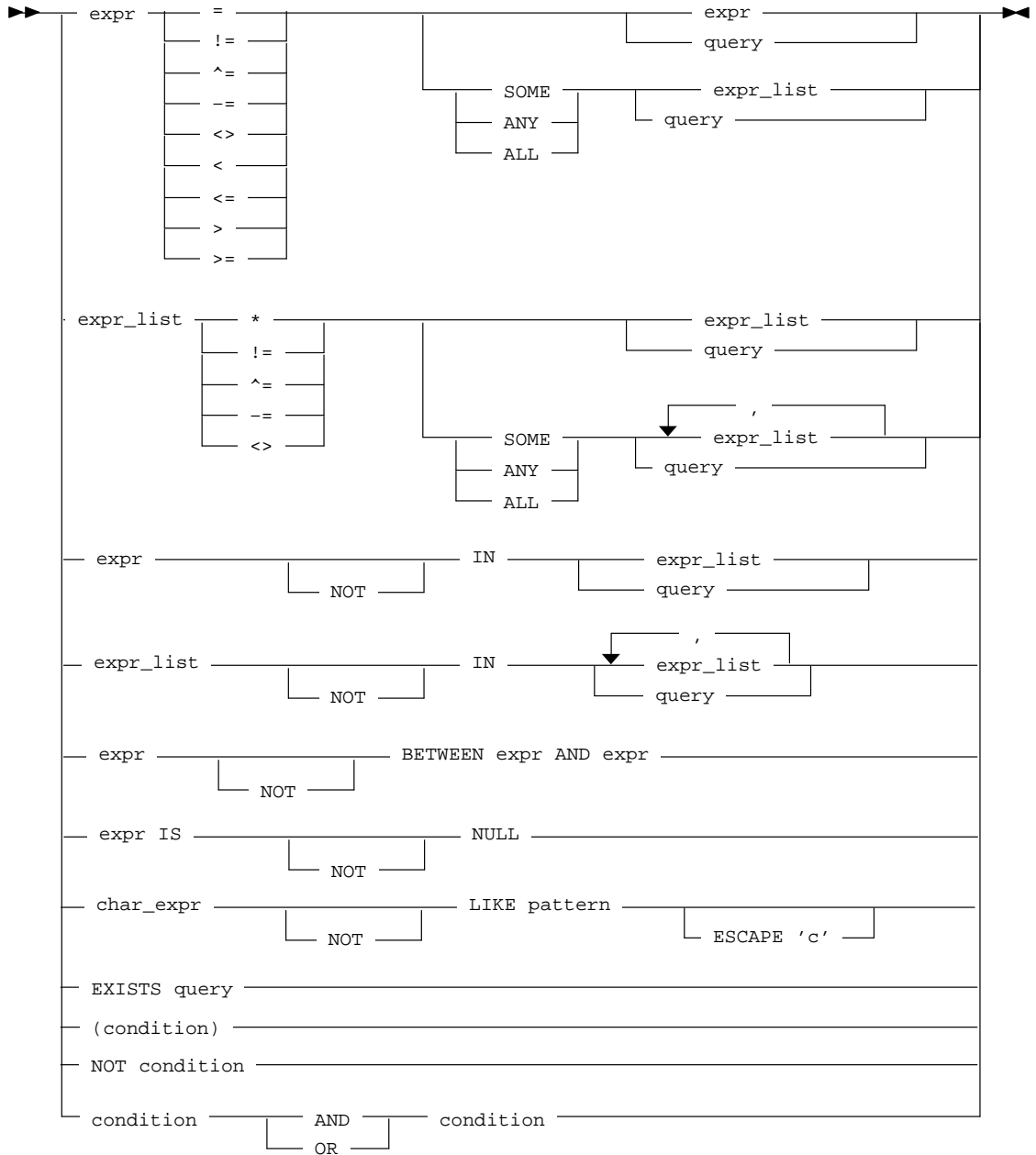

---

## Operators and Operator Precedence

### Arithmetic Operators

<i>Operator</i>	<i>Function</i>
<code>+-</code> (one operand)	Denotes a positive or negative expression.
<code>*/</code>	Multiplication and division.
<code>+-</code> (two operands)	Addition and subtraction.

### Logical Operators

<i>Operator</i>	<i>Function</i>
<code>  </code>	Concatenates character values.

### Logical Operators

<i>Operator</i>	<i>Function</i>
<code>NOT</code>	reverses a logical expression's result
<code>AND</code>	Combines two or more logical expressions: TRUE if all are true; otherwise FALSE.
<code>OR</code>	Combines two or more logical expressions: TRUE if any are true; otherwise FALSE.

### Comparison Operators

<i>Operator</i>	<i>Function</i>
<code>=</code>	Tests for equality.
<code>!= ^= = &lt;&gt;</code>	Tests for inequality.
<code>&gt; &gt;= &lt; &lt;=</code>	Greater than, greater than or equal to, less than, less than or equal to.
<code>IN</code>	Equal to any member of a set or subquery. Also equivalent to <code>'!=ANY'</code> .
<code>NOT IN</code>	Not equal to any member of a set or subquery. Also equivalent to <code>'!=ALL'</code> .
<code>ANY,SOME</code>	True if the condition is satisfied by one or more values contained in a list of expressions or returned by a subquery.
<code>ALL</code>	True if the condition is satisfied by all values contained in a list of expressions or returned by a subquery.
<code>[NOT]between x and y</code>	[Not] greater than or equal to x and less than or equal to y.
<code>[NOT] EXISTS</code>	TRUE if a subquery returns [does not return] at least one row.

**[NOT] LIKE p [ESCAPE 'c']** Matches [does not match] a specified pattern. '%' matches any sequence of characters; '\_' matches any single character. The ESCAPE character preceding '%' or '\_' causes them to be treated literally. Matches multiple bytes for a multi-byte character.

**IS [NOT] NULL** Is [not] null.

## Set Operators used in SELECT Statements

<b>Operator</b>	<b>Function</b>
UNION	Combines two queries; returns all distinct rows returned by either individual query.
UNION ALL	Combines two queries; returns all rows returned by either query, including duplicates.
INTERSECT	Combines two queries; returns all distinct rows returned by both individual queries.
MINUS	Combines two queries; returns all distinct rows returned by the 1st but not by the 2nd.
(+)	Indicates that the preceding column is an outer join column.
*	Wildcard operator used instead of column names to select all columns from a table or view.
PRIOR	Used in a tree-structured query to define a parent-child relationship between nodes in a tree-structured query. See SELECT.
ALL	Retains duplicate rows in a query (ALL is the default, as compared to DISTINCT).
DISTINCT	Eliminates duplicate rows from the result of a query.

## Operator Precedence

When evaluating an expression, ORACLE evaluates operators with greater precedence first. Operators on the same line have the same precedence.

Note: Parentheses() override normal precedence. ORACLE evaluates operators inside parentheses before those outside. Without parentheses, operators at the same precedence are evaluated from left to right.

### **SQL Operator Precedence**

+ - unary arithmetic operators	PRIOR operator
* / arithmetic operators	
+ - binary arithmetic operators	character operator

All comparison operators

NOT logical operator

AND logical operator

OR logical operator

### Arithmetic Operator Precedence

+ - unary arithmetic operators

\* / arithmetic operators

+ - binary arithmetic operators

---

## SQL Commands

### ALTER CLUSTER

Redefines storage allocations for an existing cluster.

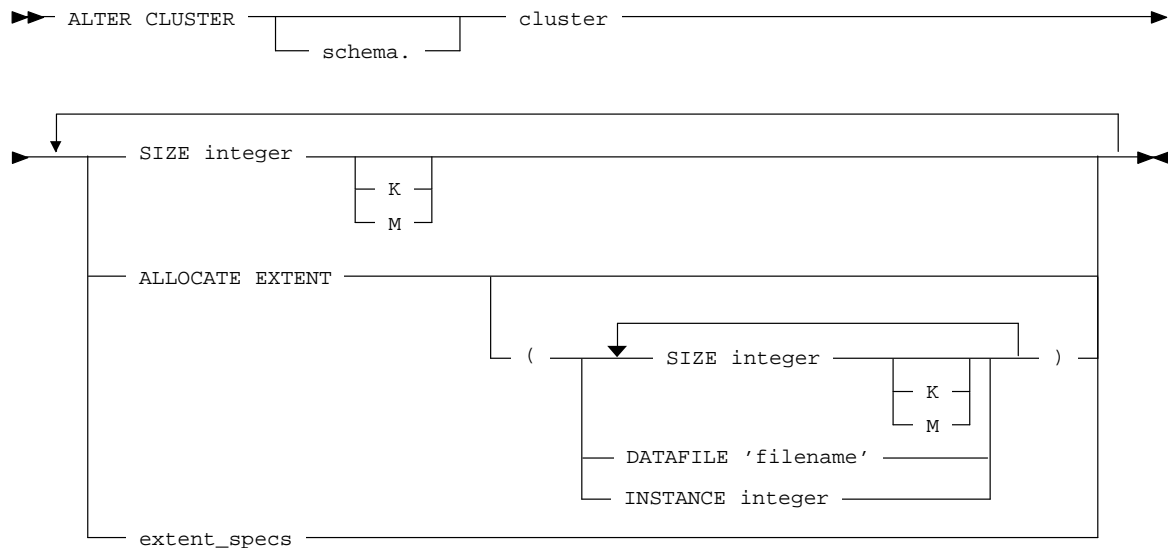

### ALTER DATABASE

Changes the operation of the database with respect to redo log files and database files. Backs up control files and archives redo log files. Mounts, dismounts, opens and closes a database. Performs media recovery.

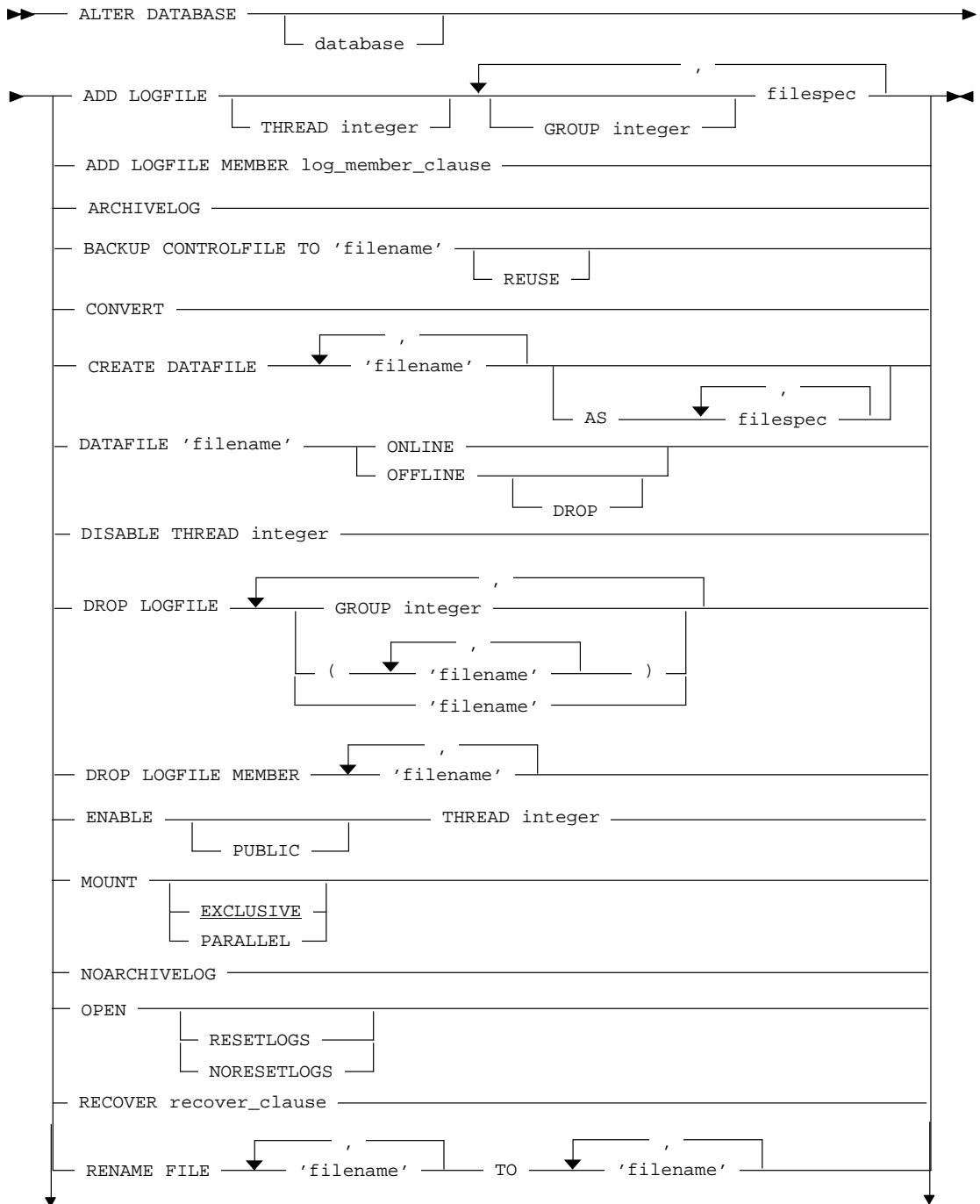

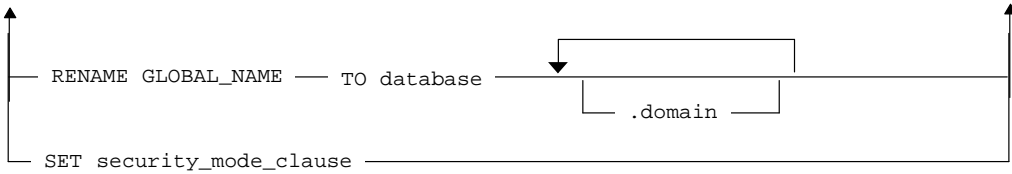

**log\_member\_clause ::=**

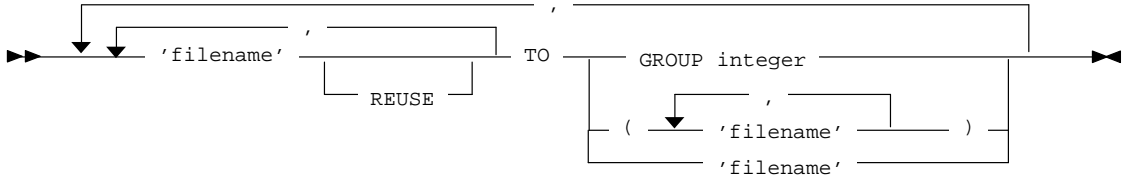

**recover\_clause ::=**

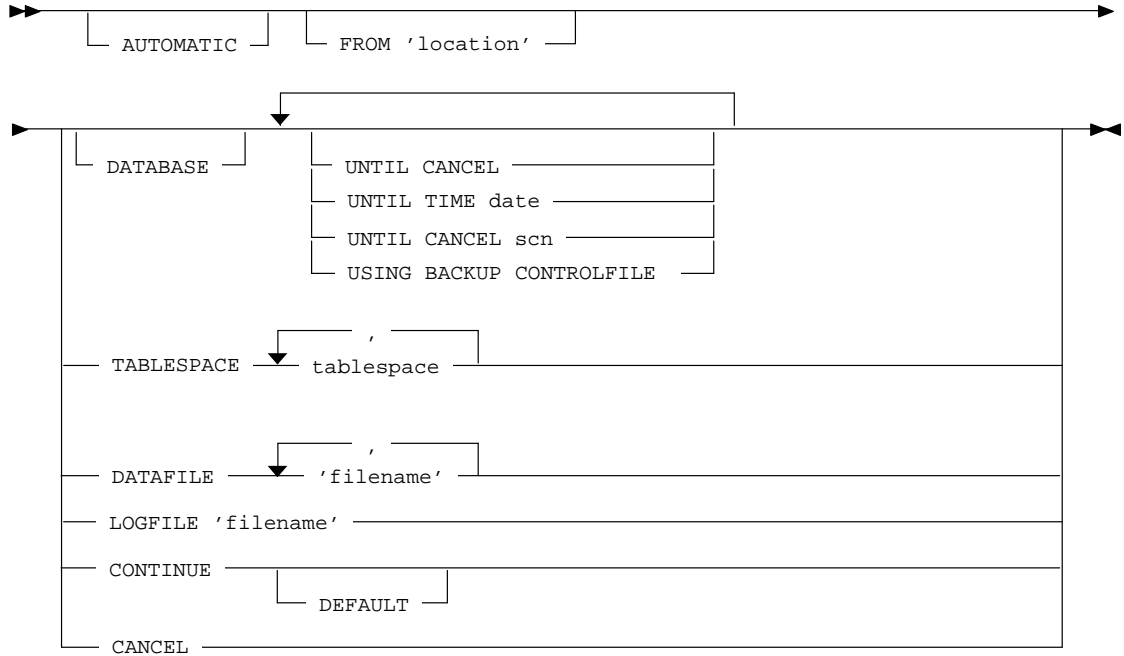

**security\_mode\_clause ::=**



## ALTER FUNCTION

Recompiles a standalone function.

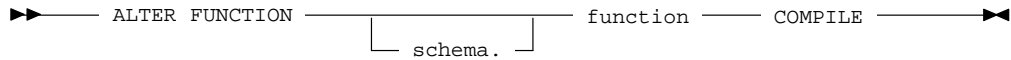

## ALTER INDEX

Redefines storage allocations for an existing index.

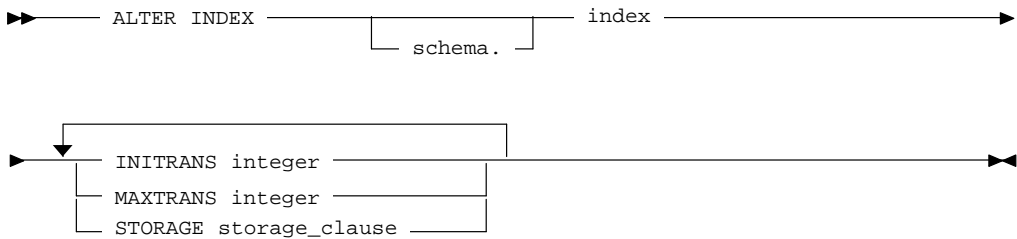

## ALTER PACKAGE

Recompiles the specification or body of a stored package.

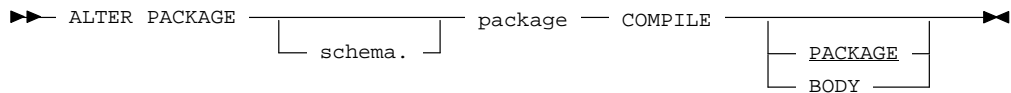

## ALTER PROCEDURE

Recompiles a stand-alone stored procedure.

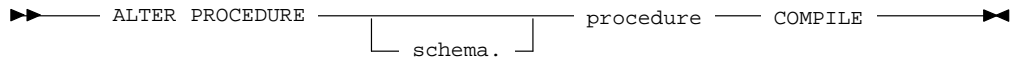

## ALTER PROFILE

Add, modify, or remove a resource limit in a profile.

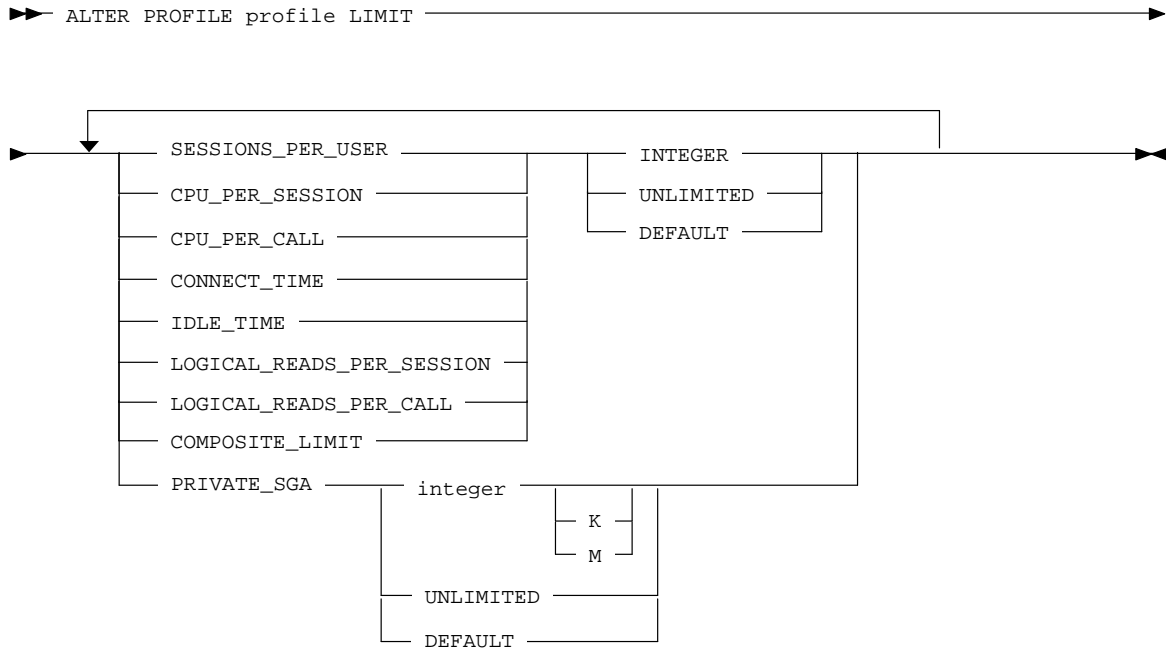

## ALTER RESOURCE COST

Specify a formula to calculate the total resource cost for a session.

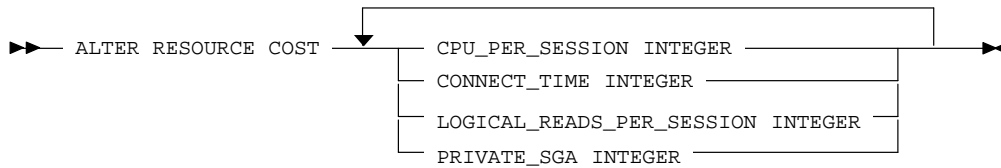

## ALTER ROLE

Changes the authorization needed to enable a role.

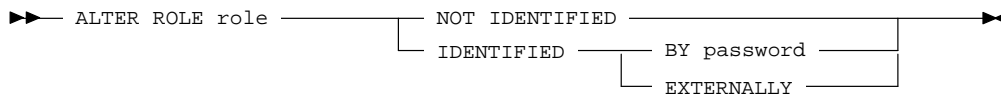

## ALTER ROLLBACK SEGMENT

Redefines storage allocations for an existing rollback\_segment,

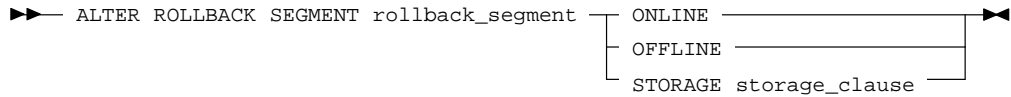

## ALTER SEQUENCE

Redefines an existing sequence.

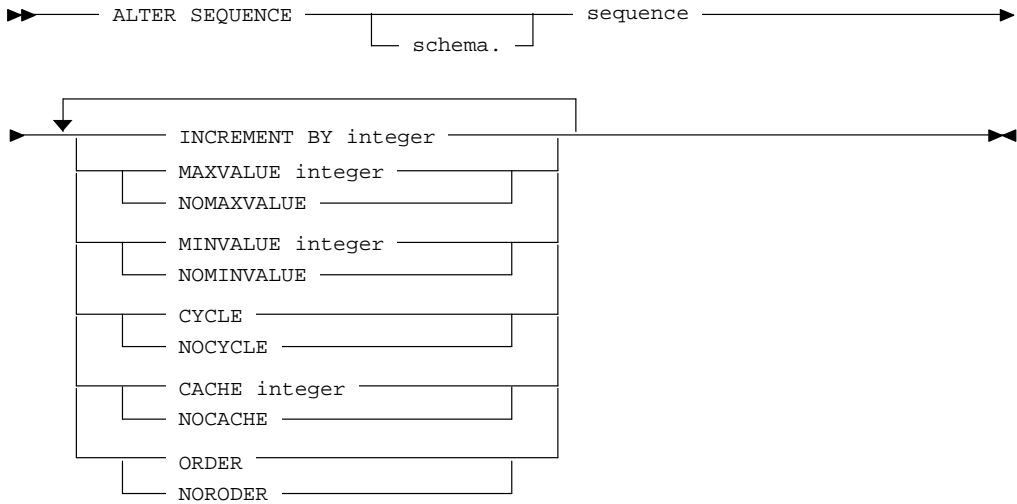

## ALTER SESSION

Modifies the current user session by enabling and disabling the SQL trace facility, changing national language characteristics, or closing a remote database link.

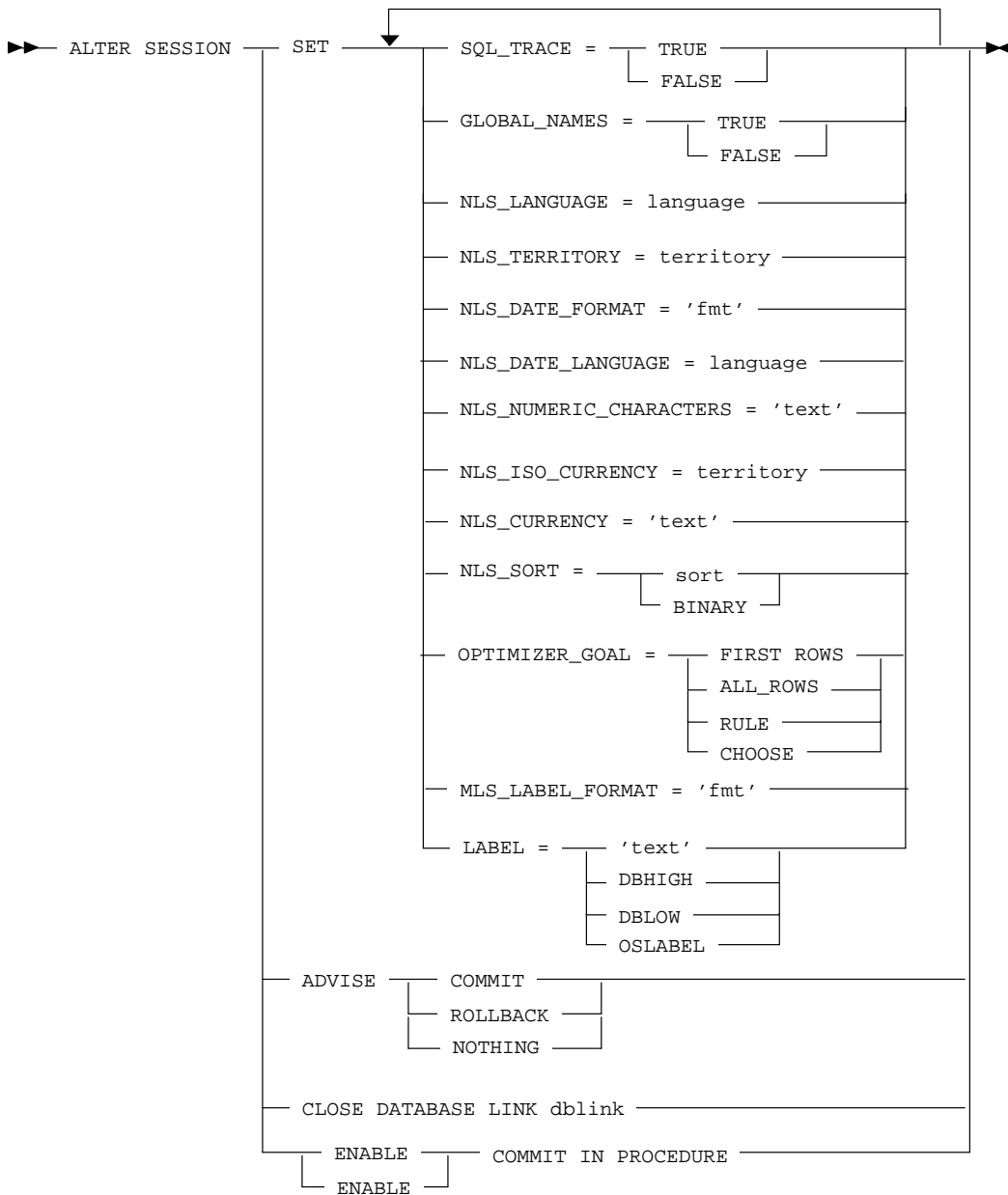

## ALTER SNAPSHOT

Change storage characteristics or redefine the refresh time and mode for a snapshot.

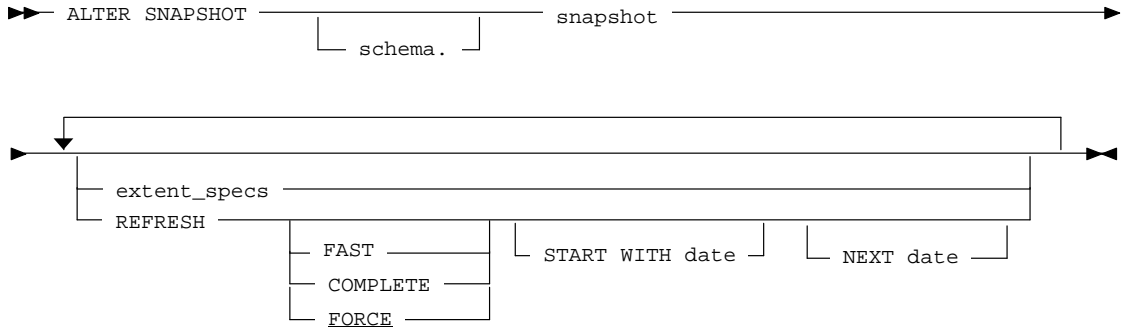

### ALTER SNAPSHOT LOG

Change storage characteristics or remove rows from a snapshot log.

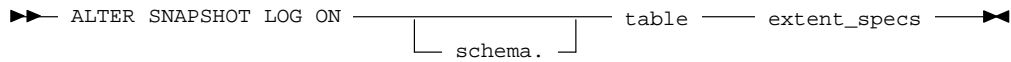

### ALTER SYSTEM

Perform a specialized system function.

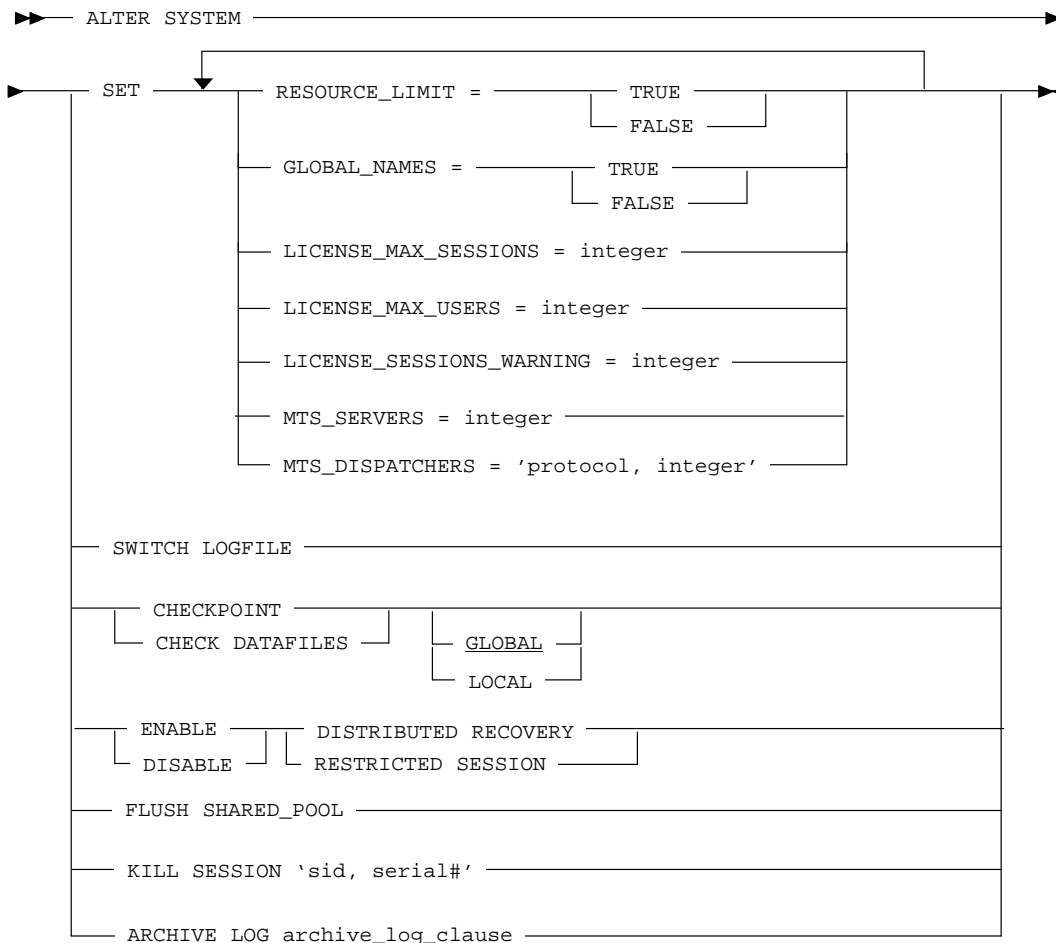

**archive\_log\_clause ::=**

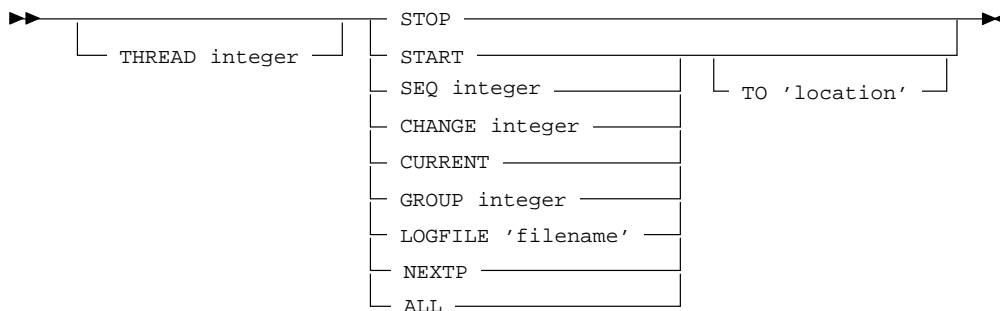

**ALTER TABLE**

Redefines the columns, constraints, or storage allocations of an existing table.

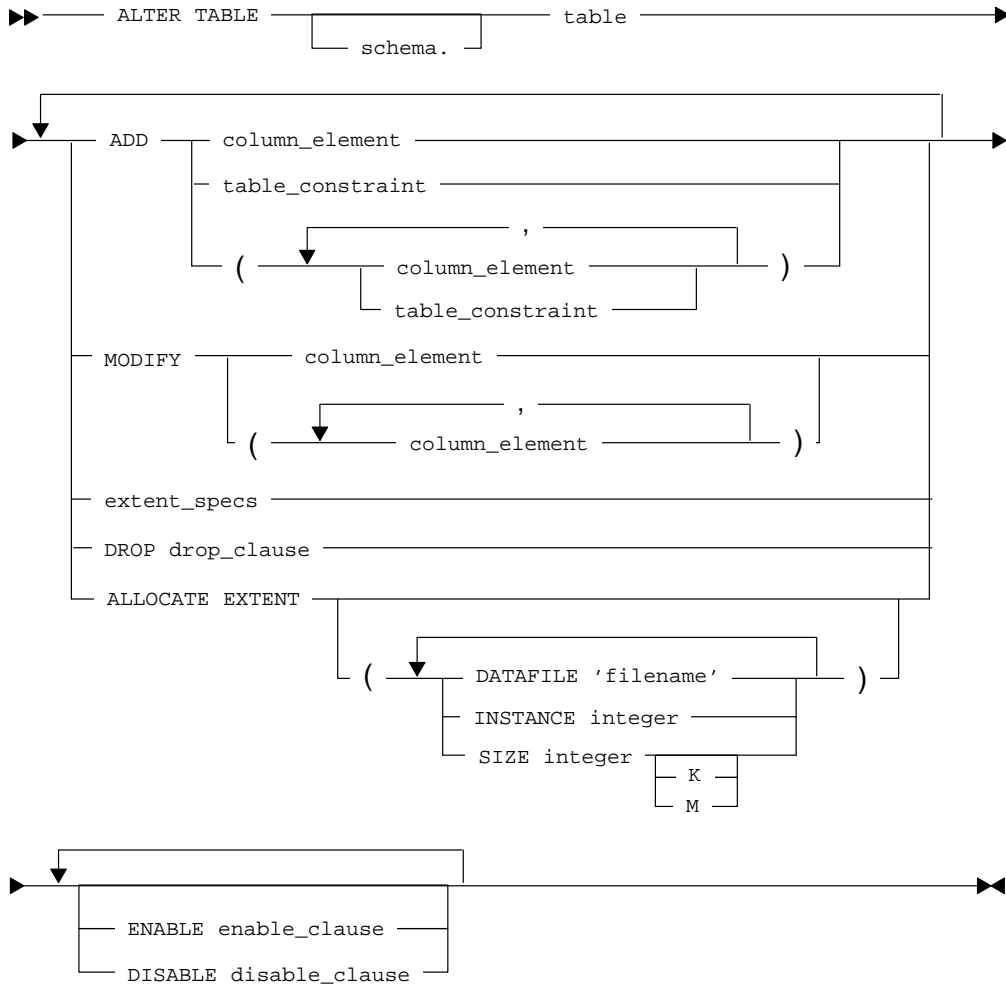

**drop\_clause ::=**

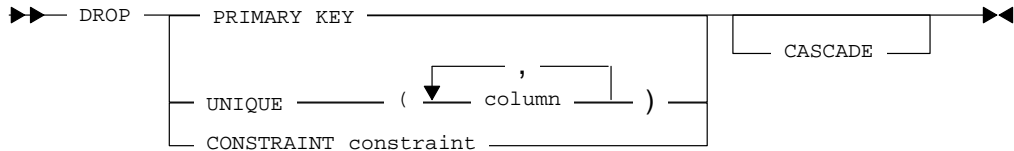

## ALTER TABLESPACE

Redefines an existing tablespace by adding or renaming a database file, or by redefining default storage allocations. Also changes the state of a tablespace by moving the tablespace online or offline, or by <%-3>signifying that a backup of the database files has begun or completed

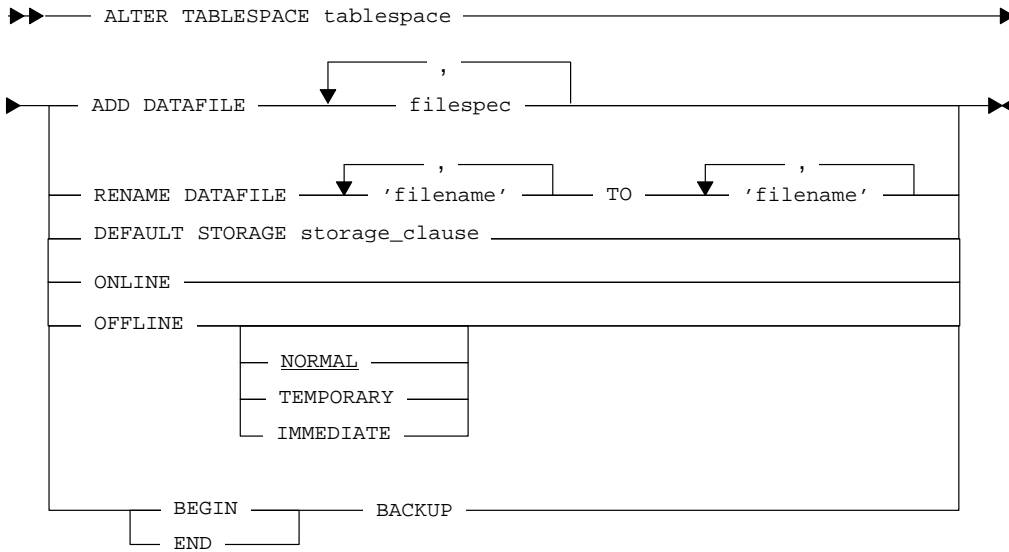

## ALTER TRIGGER

Enable, disable, or recompile a database trigger.

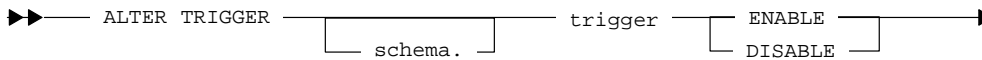

## ALTER USER

Changes the password, default tablespace, or temporary tablespace of an existing user.

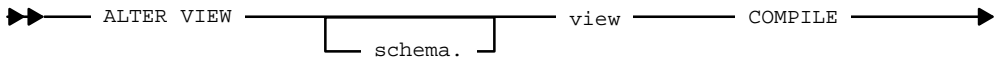
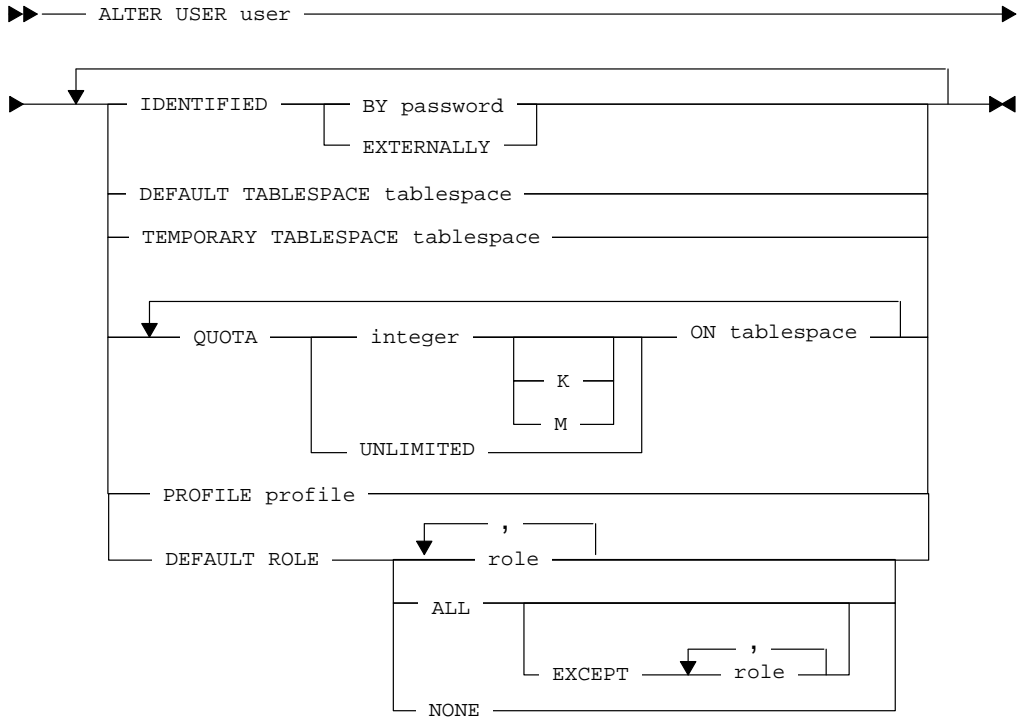

**ALTER VIEW**

Recompiles a database view, affecting dependencies.

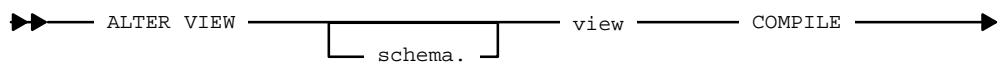

**ANALYZE**

Validates the structure of an index, table, or cluster, or collects performance statistics for them.

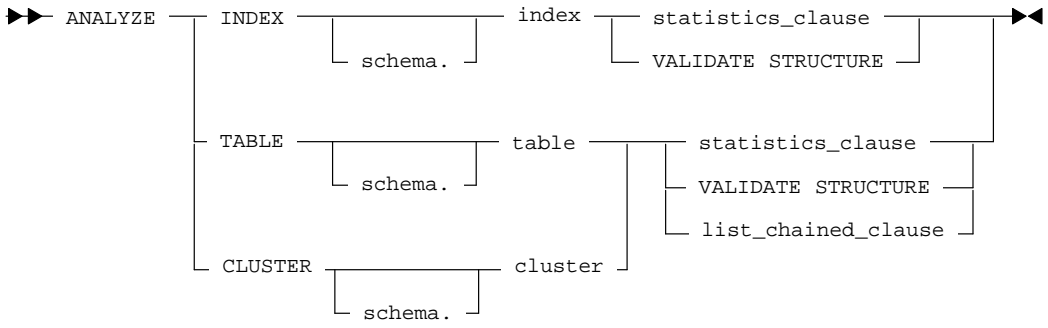

**statistics\_clause ::=**

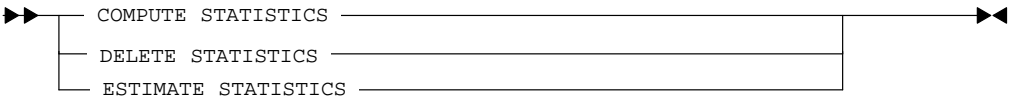

**validate\_clause ::=**

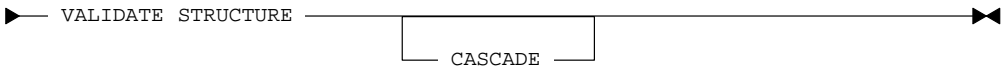

**list\_chained\_clause ::=**

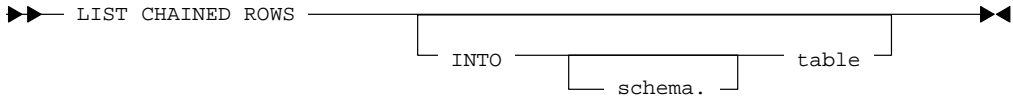

**AUDIT (Form I)**

Enables auditing of specific SQL statements or types of objects.

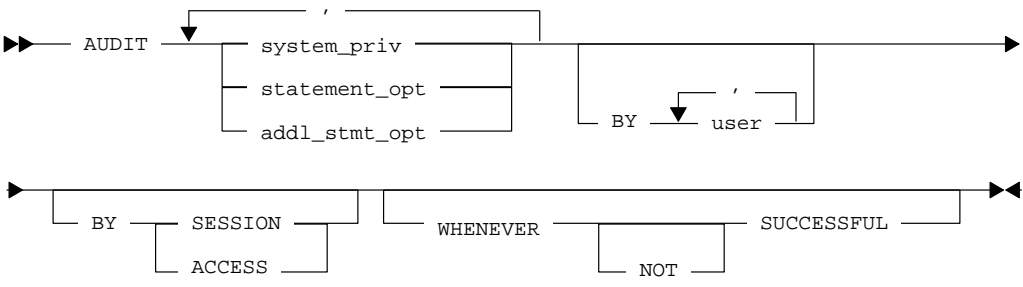

**statement\_opt ::=**

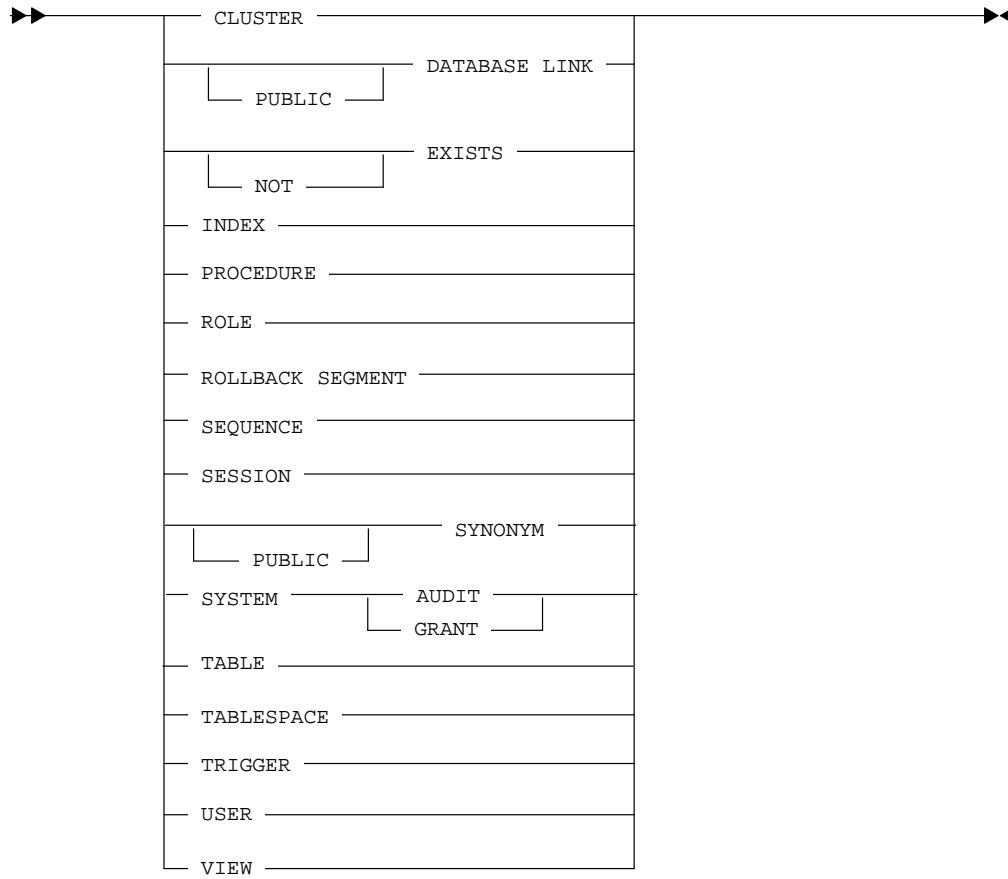

addl\_stmt\_opt ::=

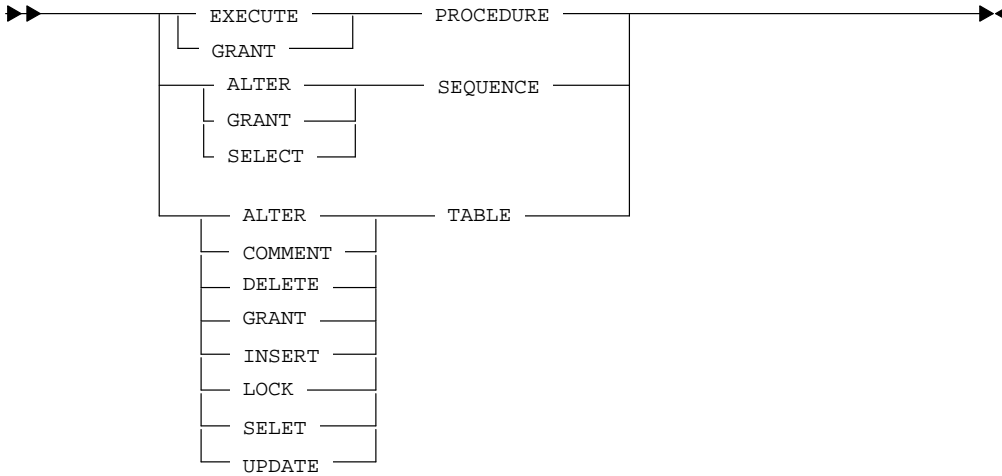

### AUDIT (Schema objects)

Enables auditing of access to specific database objects. The DEFAULT option enables auditing of all (specified) objects that are subsequently created. Auditable objects include tables, views, sequences, functions, procedures, packages, and snapshots.

Object Privilege	Table	Views	Sequences	Procedure Functions	
				Packages	Snapshots
ALTER	√		√		
AUDIT	√	√	√	√	
COMMENT	√	√			
DELETE	√	√			
EXECUTE				√	
GRANT	√	√	√	√	
INDEX	√				
INSERT	√	√			
LOCK	√	√			
RENAME	√	√		√	
SELECT	√	√	√		√
UPDATE	√	√			

SELECT	√	√	√	√
UPDATE	√	√		

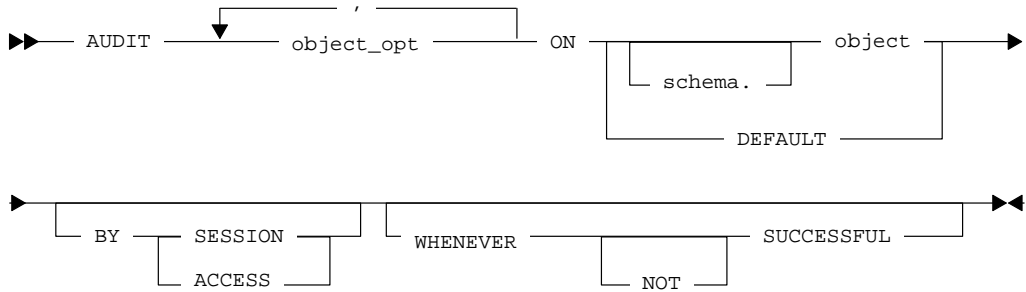

## COMMENT

Adds a comment about a table, view, or column to the data dictionary.

COMMENT command ::=

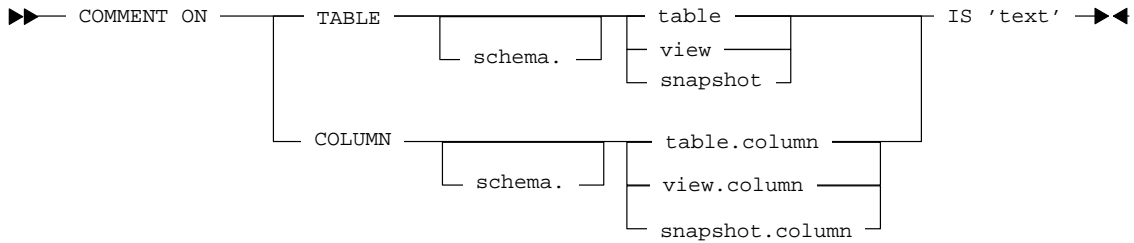

## COMMIT

Saves the changes in the current transaction to the database. Also erases the transaction's savepoints and releases the transaction's locks.

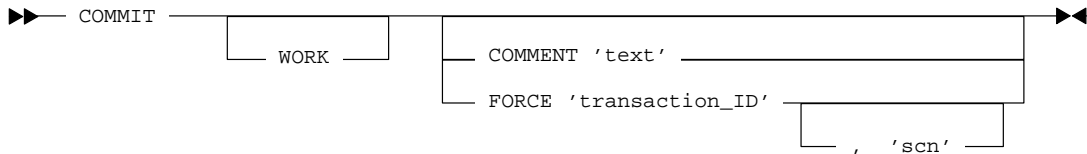

## CREATE CLUSTER

Creates a new cluster and specifies its cluster key columns.

►► CREATE CLUSTER [ schema. ] cluster ( column datatype ) ►

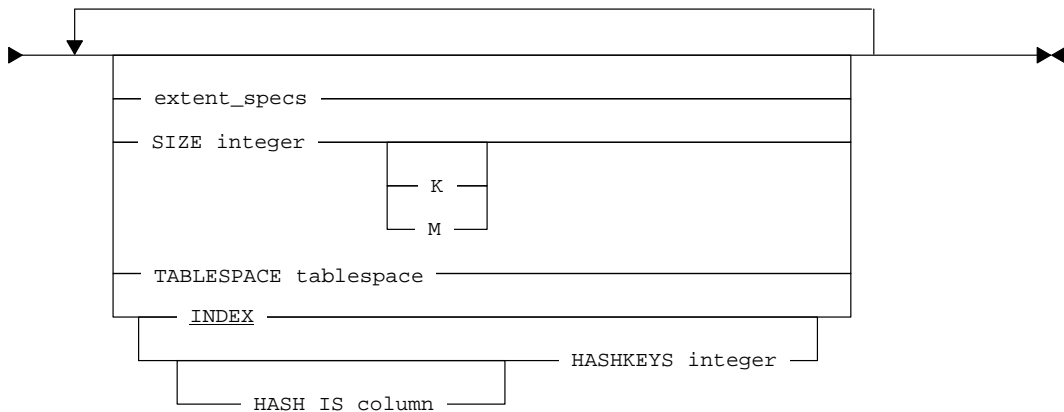

## CREATE CONTROL FILE

Recreates the database control file.

►► CREATE CONTROLFILE [ RESUE ] [ SET ] DATABASE database ►

► UNIQUE [ GROUP integer ] filwapec [ RESETLOGS ] [ NORESETLOGS ] ►

► DATAFILE [ filespec ] ►

The diagram illustrates the structure of the DATAFILE clause. It features a box containing the following elements:
 

- MAXLOGFILES integer**: A line representing the maximum number of log files.
- MAXLOGMEMBERS integer**: A line representing the maximum number of log members.
- MAXLOGHISTORY integer**: A line representing the maximum number of log history entries.
- MAXDATAFILES tablespace**: A line representing the maximum number of data files.
- MAXINSTANCES storage\_clause**: A line representing the maximum number of instances.
- ARCHIVELOG**: A line representing the archive log mode.
- NOARCHIVELOG**: A line representing the no archive log mode.

## CREATE DATABASE

Creates a new database setting the maximum numbers of instances, database files, and redo log files; specifying database files and redo log files; and choosing the mode for the redo log.

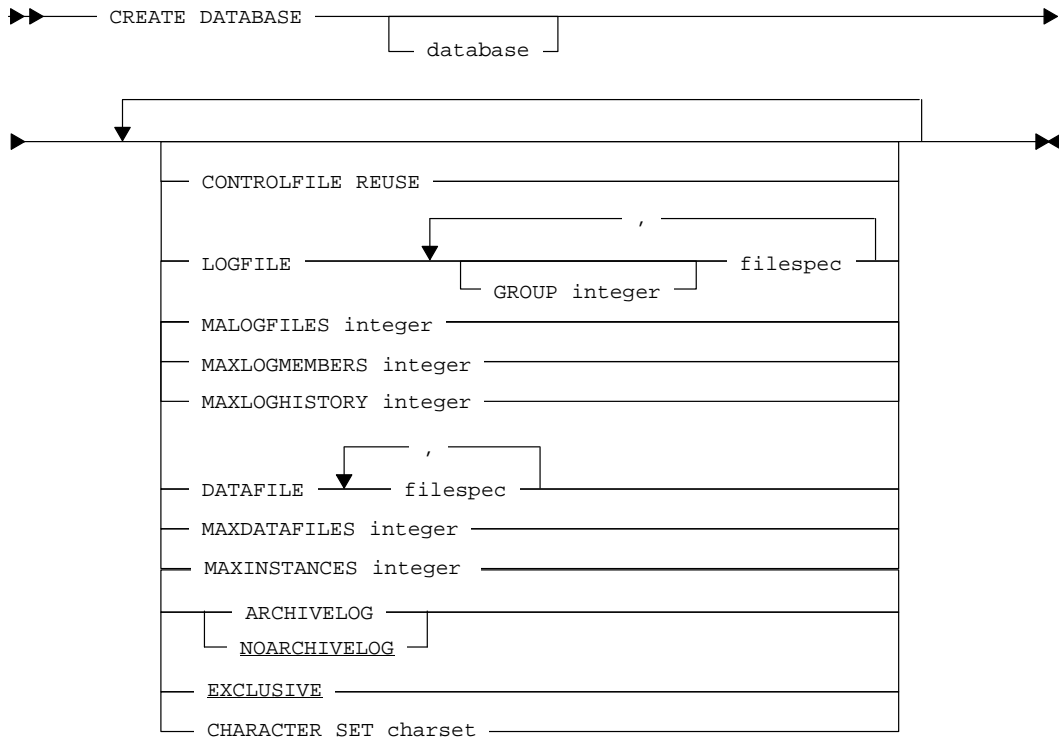

**filespec (for data files) ::=**

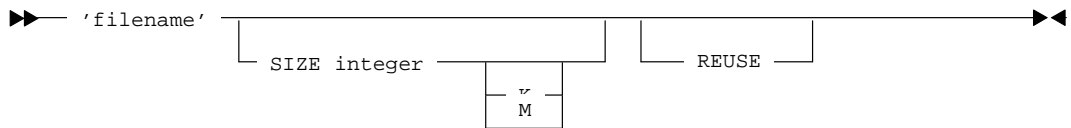

**filespec (for redo log files) ::=**

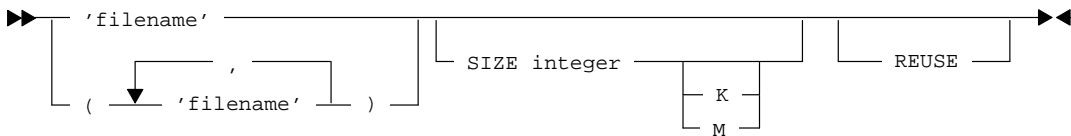

## CREATE DATABASE LINK

Creates a link from the local database to a user on a remote database specified by a connect\_string.

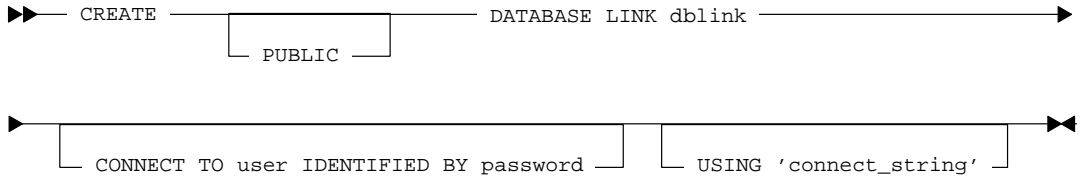

## CREATE FUNCTION

Creates a stored function.

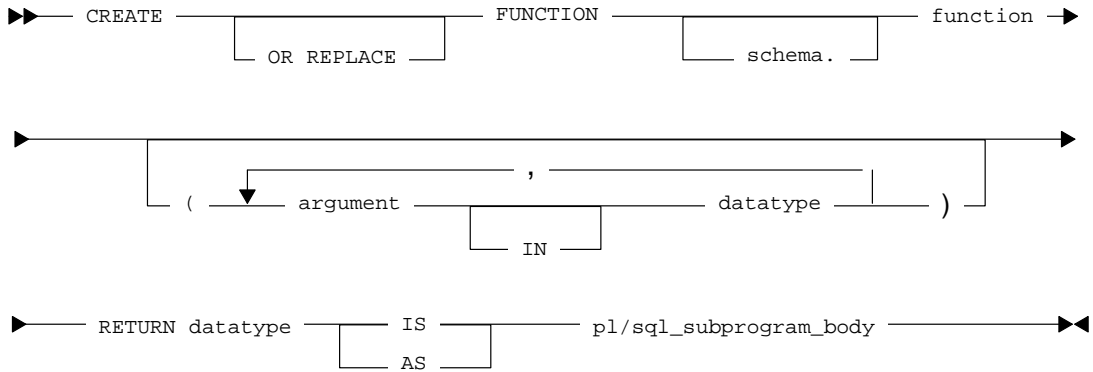

## CREATE INDEX

Creates a new index on the specified columns in a table or cluster.

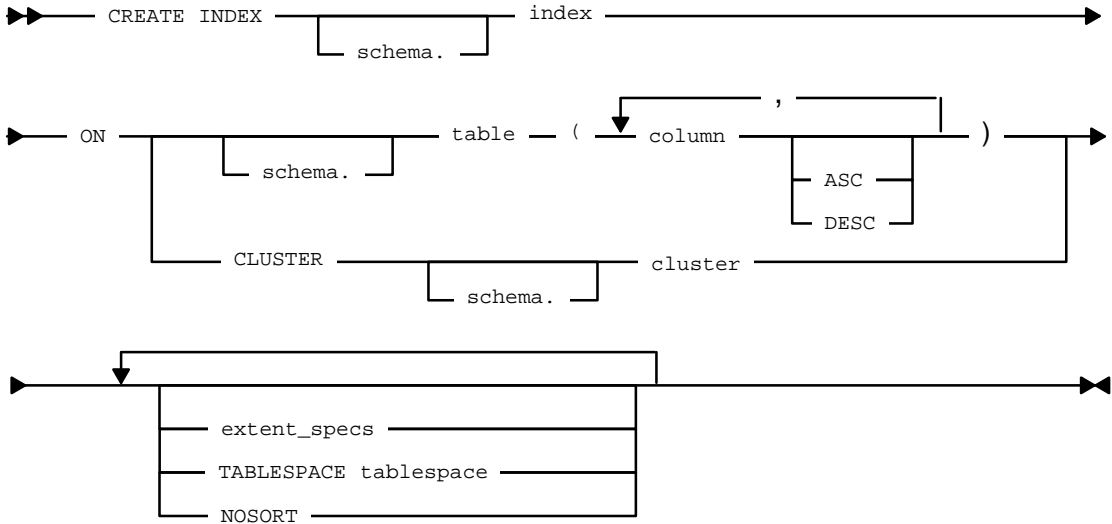

## CREATE PACKAGE

Creates a stored package specification.

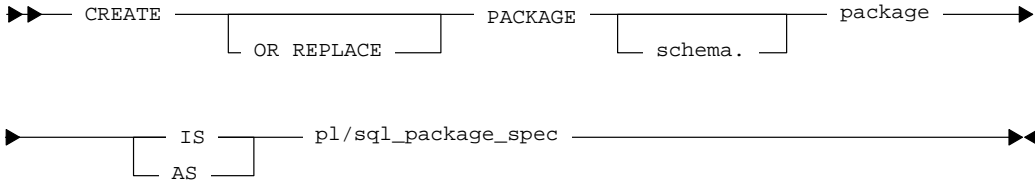

## CREATE PACKAGE BODY

Creates the body of a stored package.

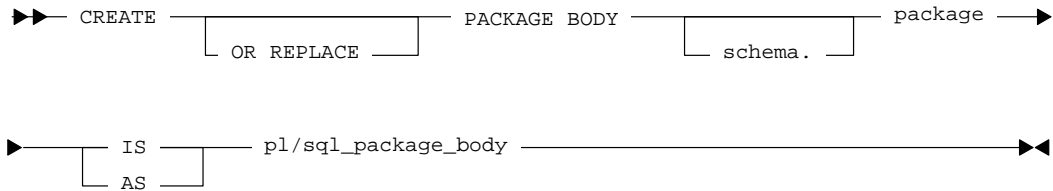

## CREATE PROCEDURE

Creates a stored procedure.

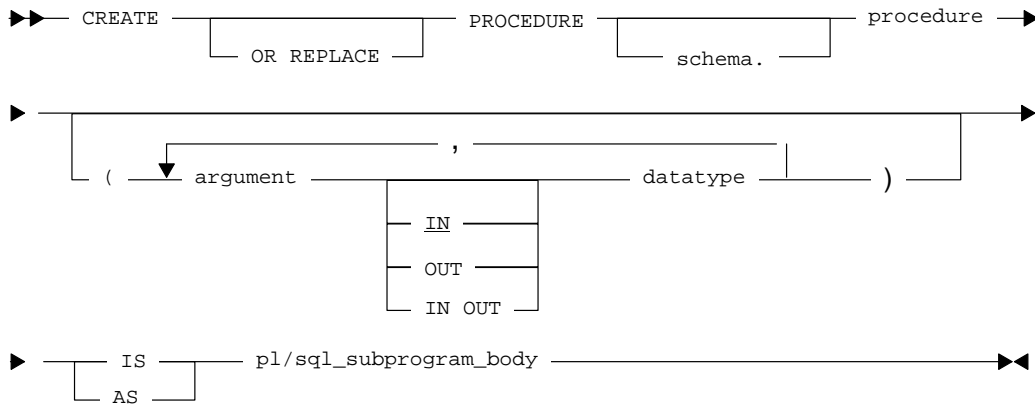

## CREATE PROFILE

Creates a user profile and specifies its resource limits.

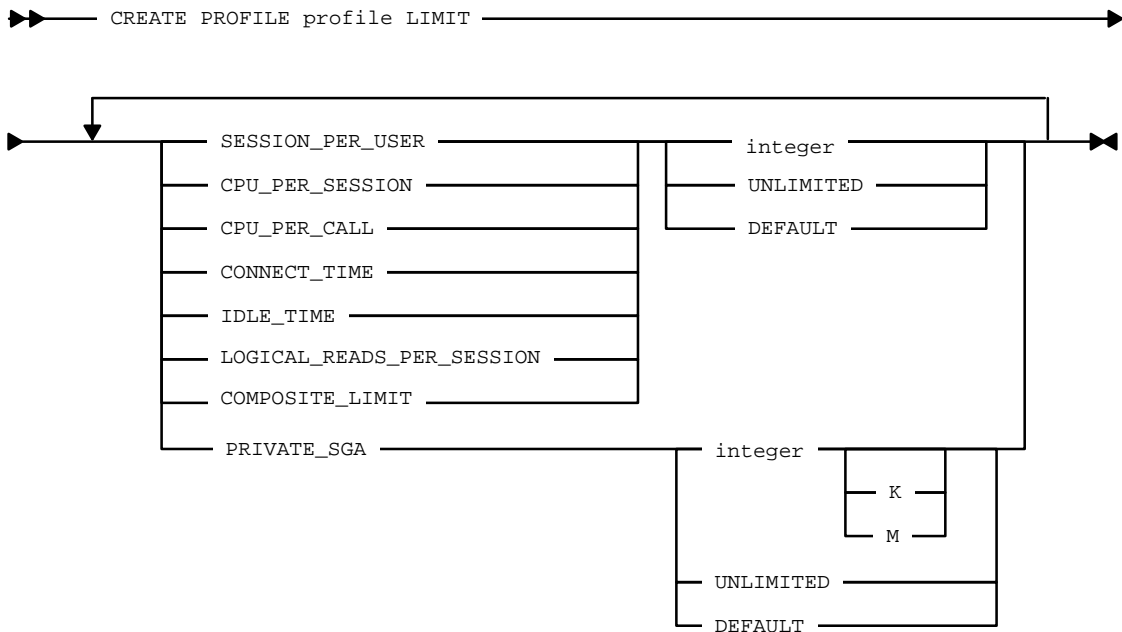

## CREATE ROLE

Creates a security role.

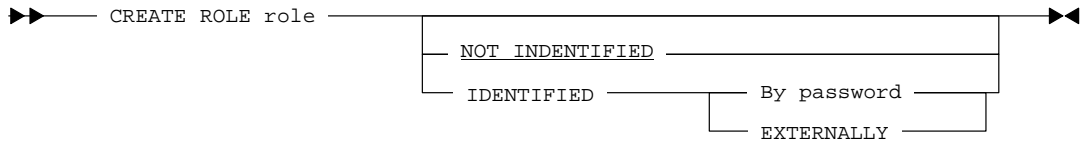

### CREATE ROLLBACK SEGMENT

Creates a new `rollback_segment`.

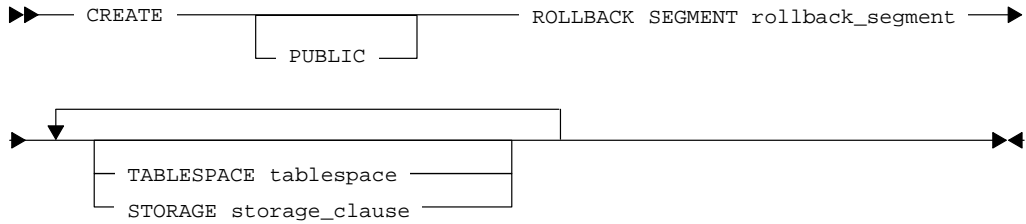

### CREATE SCHEMA

Issues multiple `CREATE TABLE`, `CREATE VIEW`, and `GRANT` commands in a single transaction.

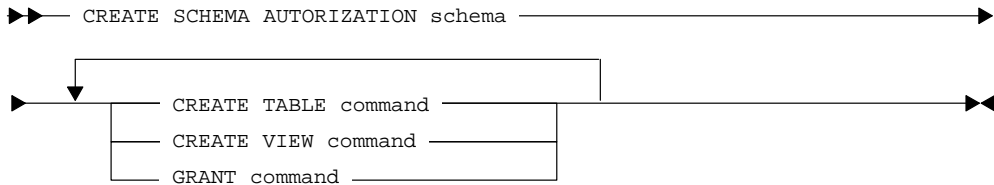

### CREATE SEQUENCE

Creates a new sequence suitable for generation of primary keys.



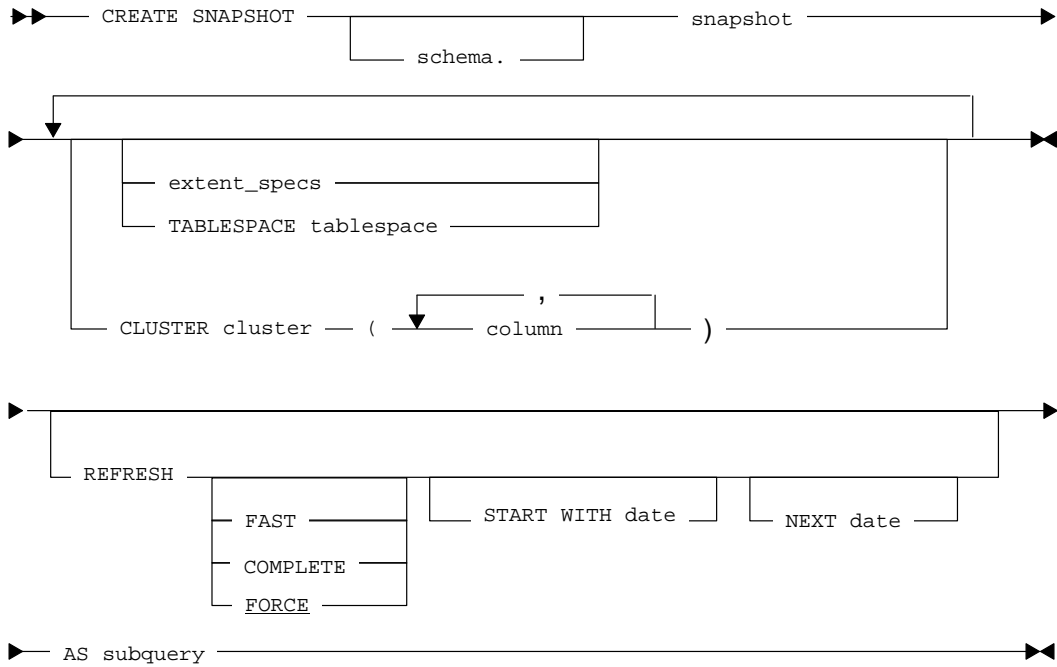

### CREATE SNAPSHOT LOG

Creates a snapshot log identifying changes made to the master table.

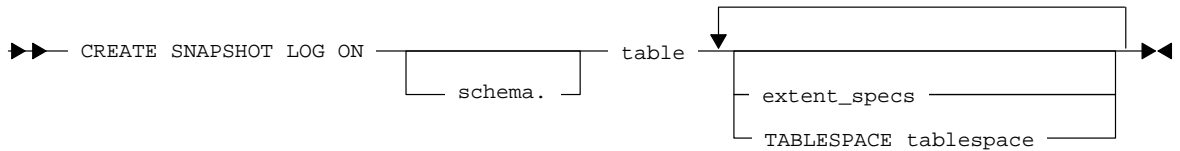

### CREATE SYNONYM

Creates a new synonym for a table, view, sequence, packaged procedure, top-level function or procedure (one that is not defined inside a package), or for another synonym.

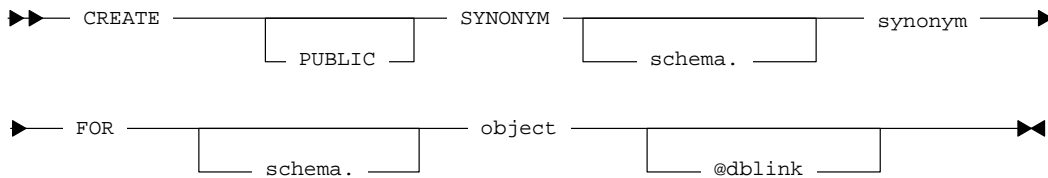

## CREATE TABLE

Creates a new table, defining its columns, constraints, and storage allocations.<%-5>

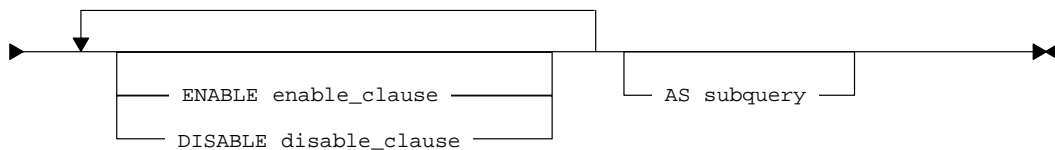
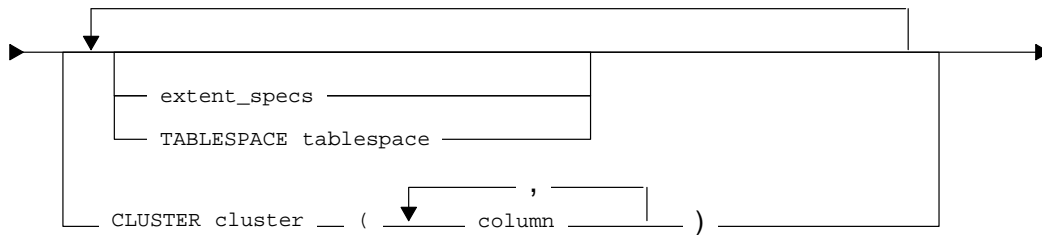
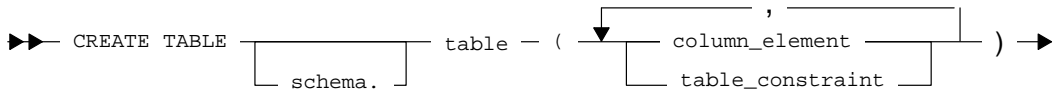

**extent\_specs ::=**



PCT\_USED is not allowed when the storage parameters are specified as part of an INDEX clause or in a CREATE INDEX statement.

**column\_element ::=**

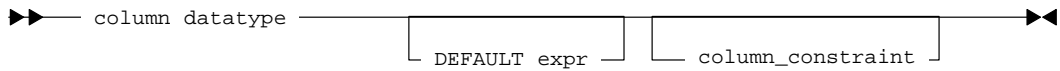

**column\_constraint ::=**

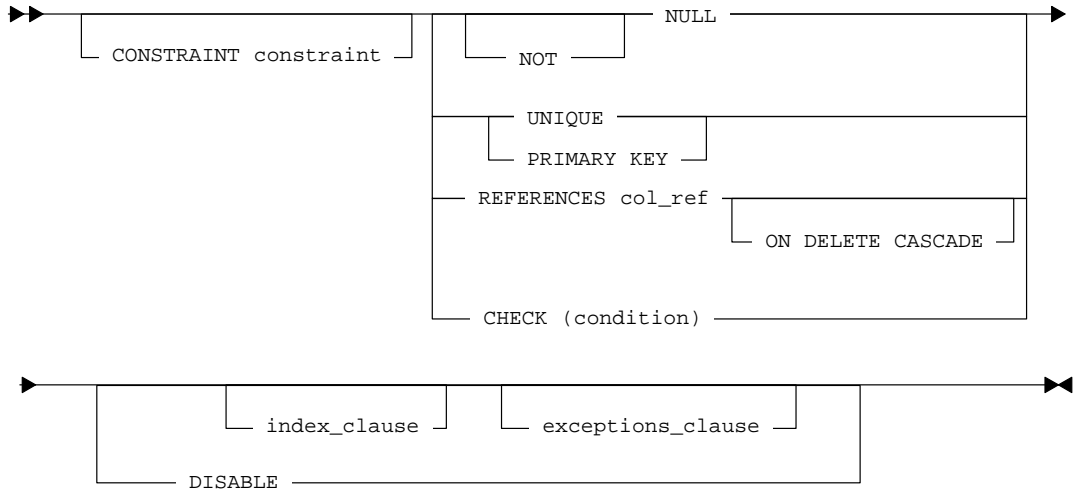

**index\_clause ::=**

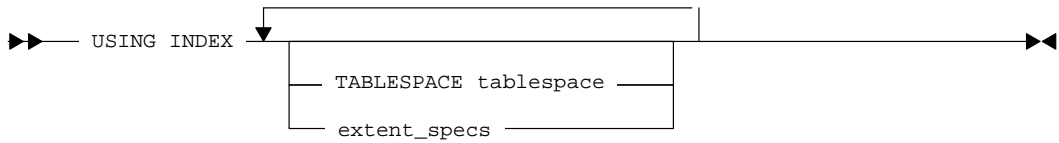

**exceptions\_clause ::=**

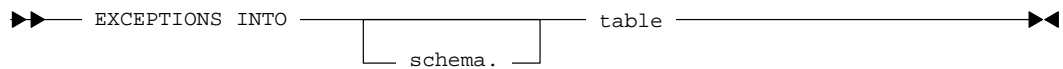

**col\_ref ::=**

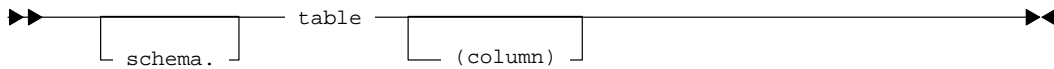

**disable\_clause ::=**

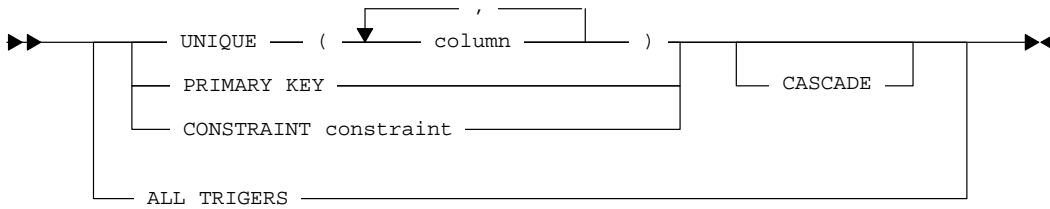

**enable\_clause ::=**

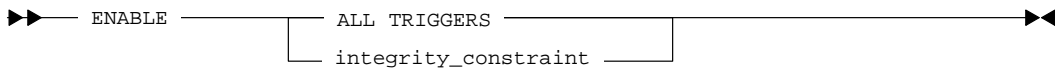

**integrity\_constraint ::=**

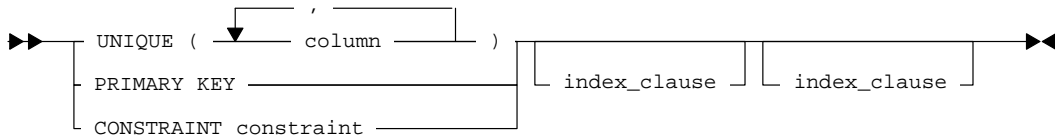

**storage\_clause ::=**

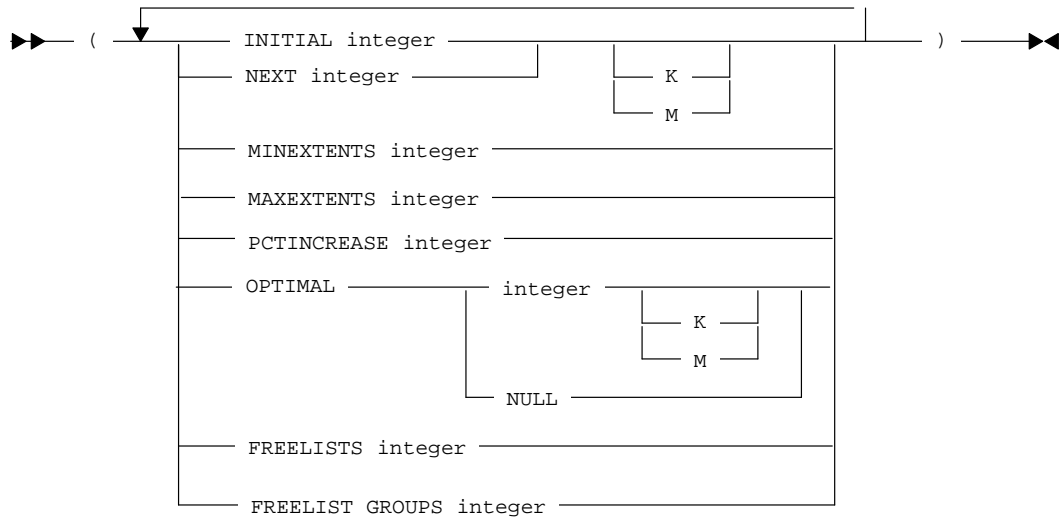

**Storage Clause Notes:**

- OPTIMAL is only allowed for rollback segments.
- FREELIST GROUPS is only allowed for tables, clusters, and indexes.
- FREELISTS is only allowed for tables and clusters.

**table\_constraint ::=**

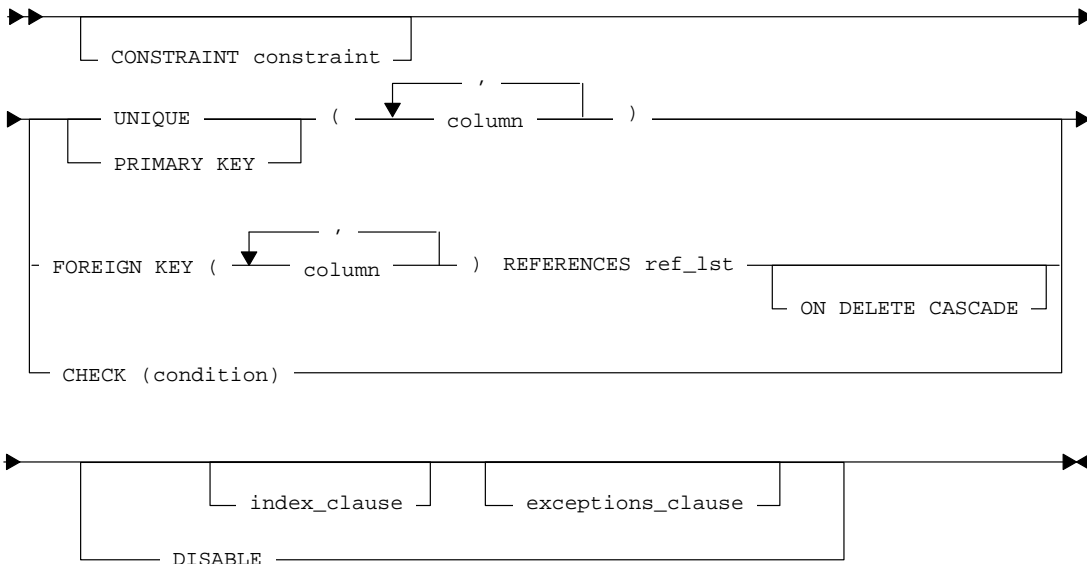

**ref\_lst ::=**

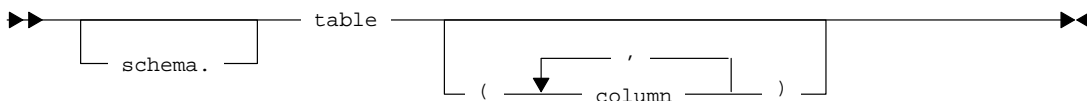

**CREATE TABLESPACE**

Creates a new area in the database for storage of tables, indexes, rollback segments, and temporary segments. Specifies the database files, the default storage allocations, and whether the tablespace is initially online or offline.

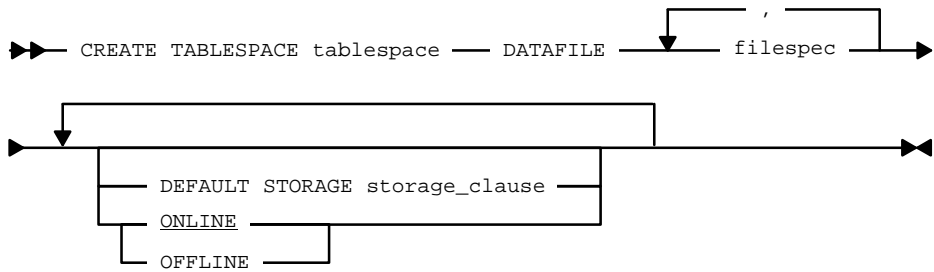

## CREATE TRIGGER

Creates a database trigger.

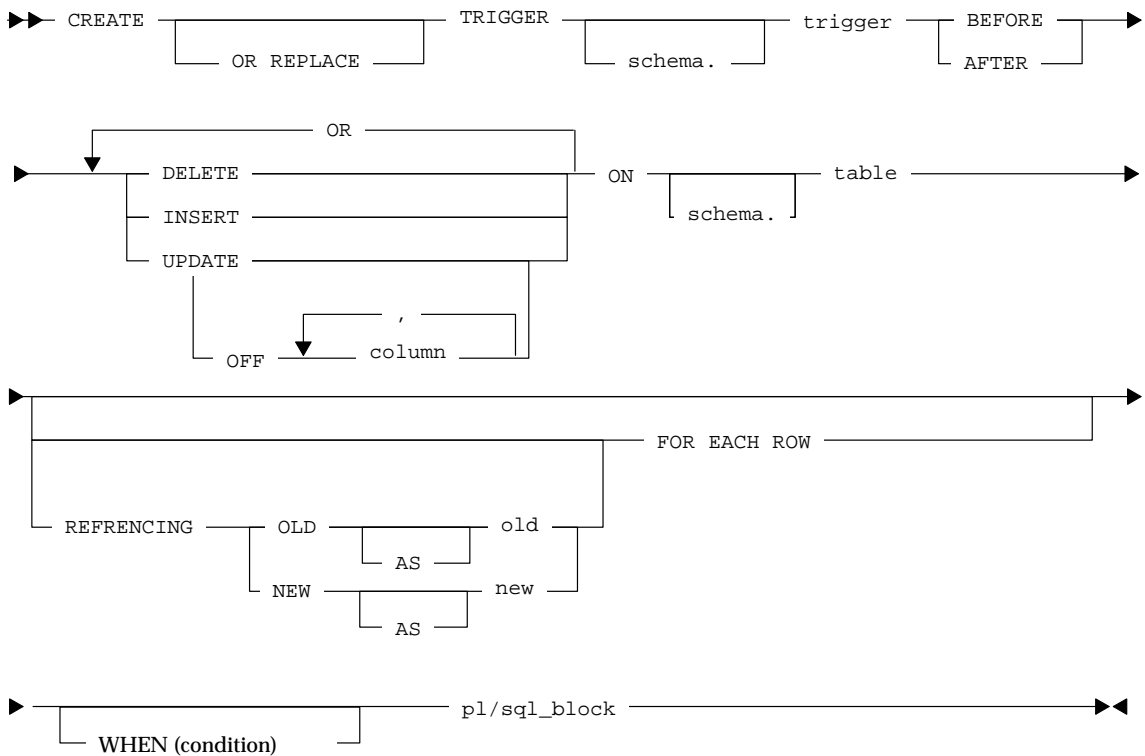

## CREATE USER

Defines a database user.

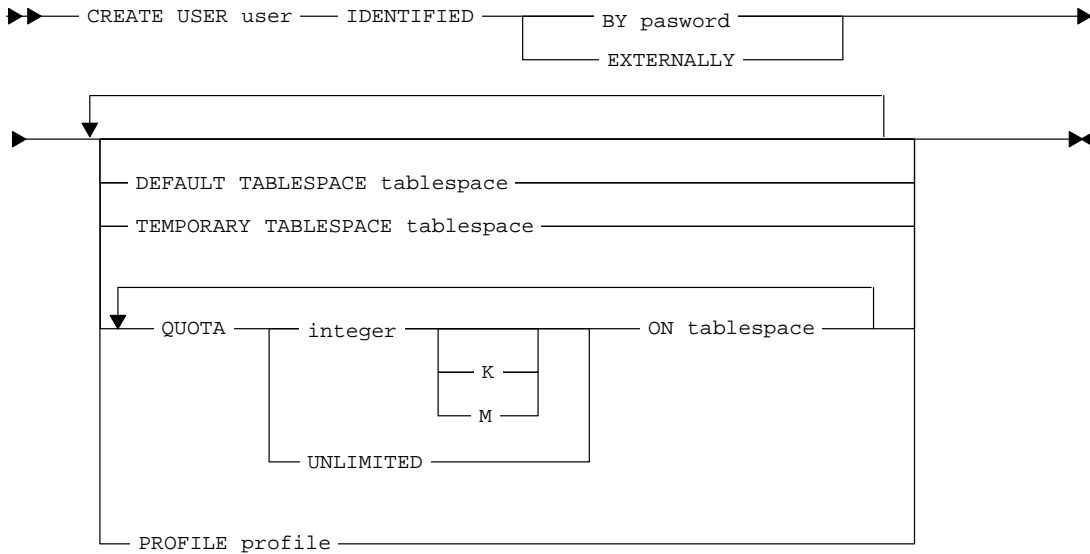

## CREATE VIEW

Creates a new view of one or more tables and/or other views.

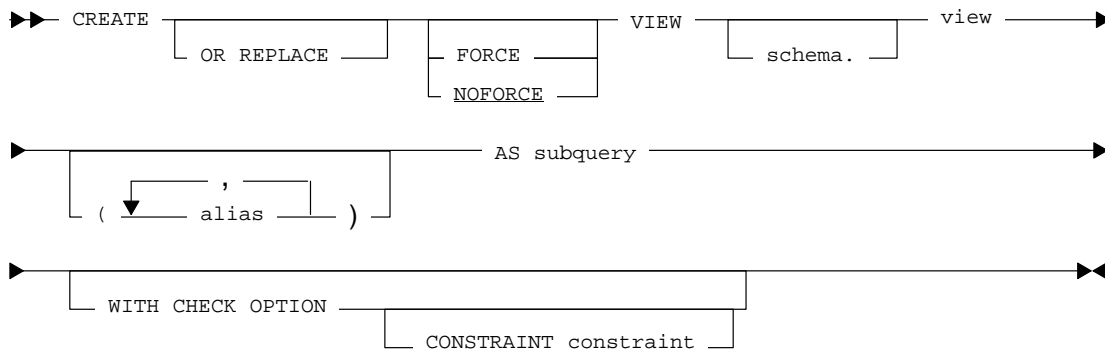

## DELETE

Removes rows from a table or view that meet the WHERE condition. Removes all rows if no WHERE clause is specified.

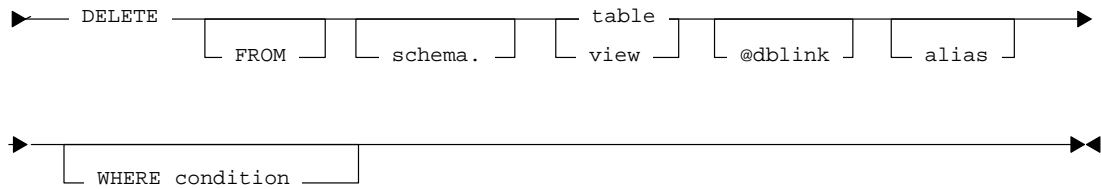

## DROP

This command removes objects from the database. The appropriate privileges are required for each object. For example, removing a PUBLIC database link requires the DROP PUBLIC DATABASE LINK privilege.

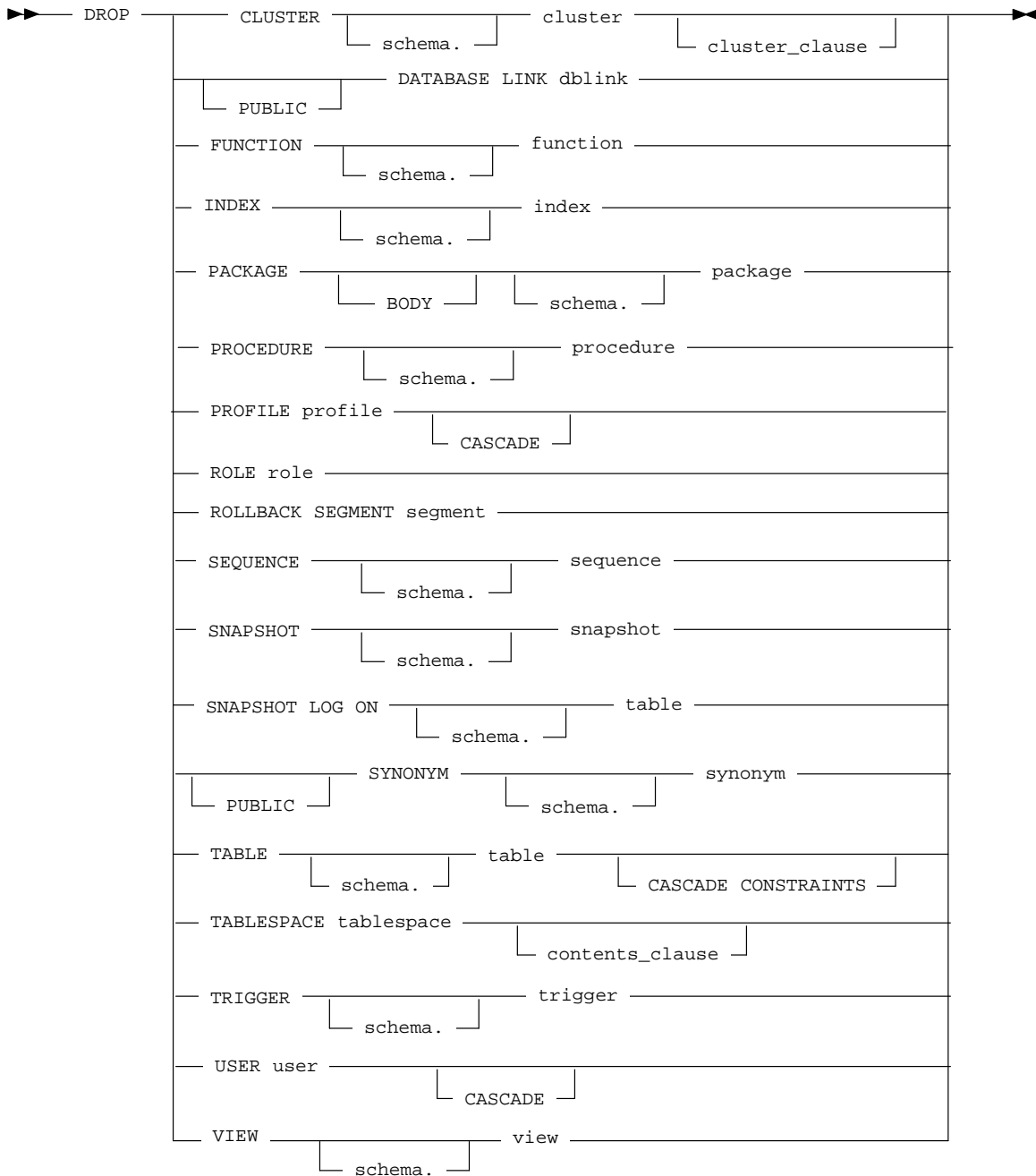

**cluster\_clause ::=**



**contents\_clause ::=**



## EXPLAIN PLAN

Describes each step of the execution plan for a SQL statement and optionally places the description in a plan table.

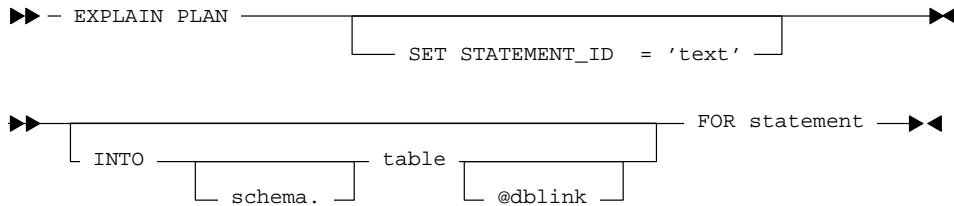

## GRANT (System Privileges and Roles)

Gives system privileges to users and other roles.

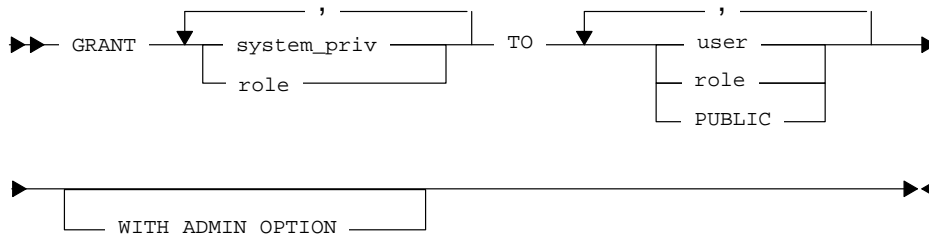

## GRANT (Object Privileges)

Gives privileges for a particular object (a table, view, synonym, package, procedure, etc.) to users and to roles.

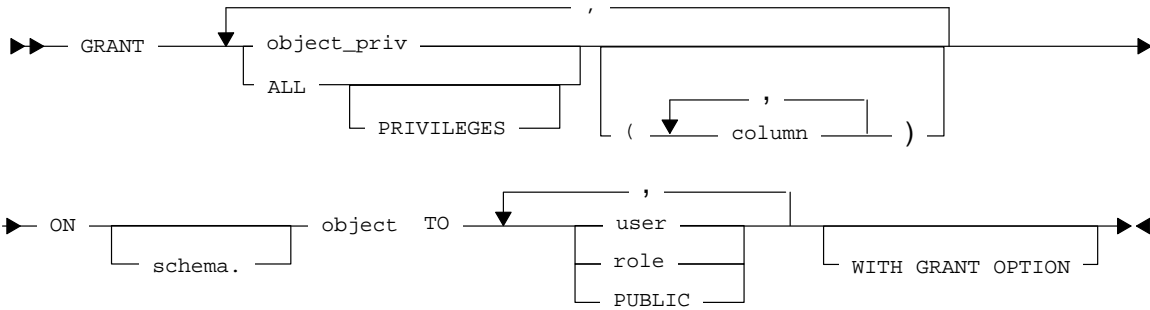

## INSERT

Adds new rows to a table or view.

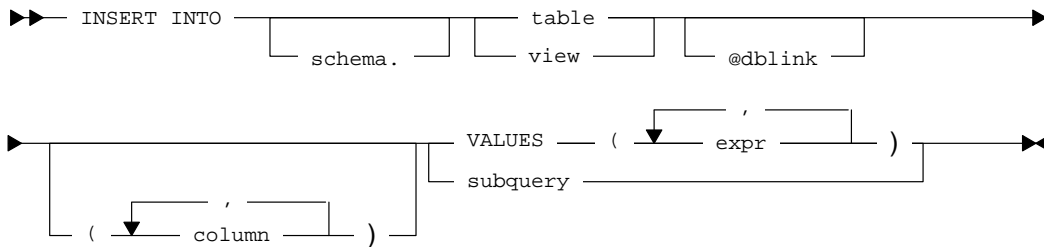

## LOCK TABLE

Overrides default lock mode and reserves access to a table for the current transaction. Permits or restricts access by other users.

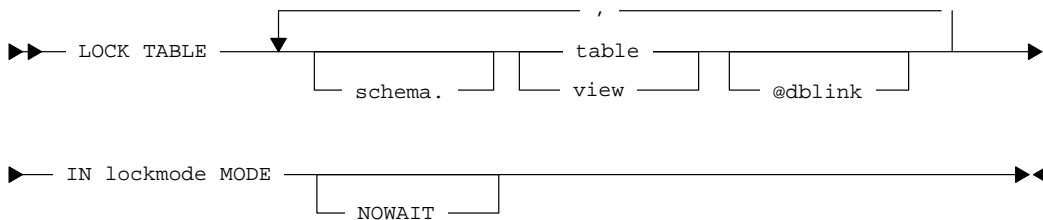

## NOAUDIT (SQL Statements)

Disables auditing of specific SQL statements, as established by Form I of the AUDIT command.

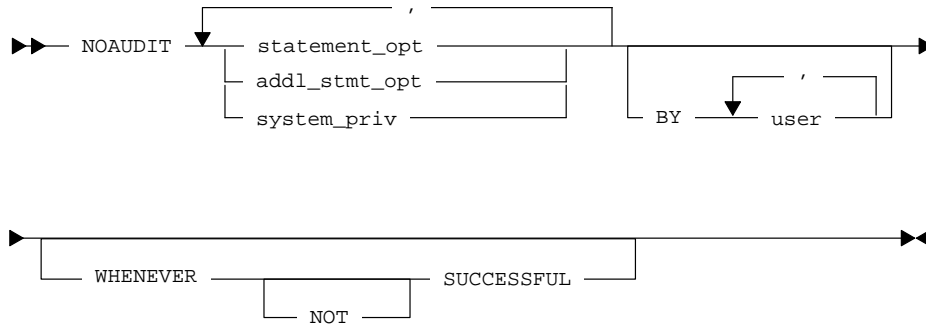

### NOAUDIT (Form II)

Disables auditing of specific database objects, as established by Form II of the AUDIT command.

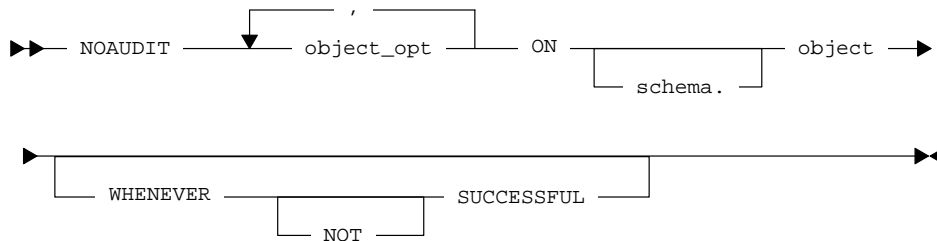

### RENAME

Renames a table, view, or synonym from *old* to *new*.



### REVOKE (Form I)

Revokes system privileges and roles from users and from roles. Reverses the action of the GRANT (System Privileges and Roles) command.

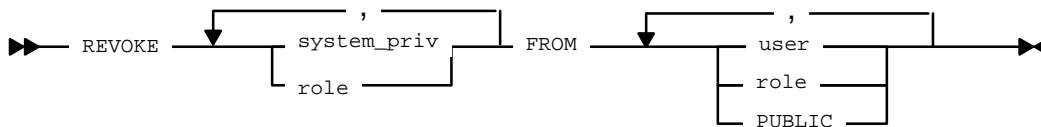

### REVOKE (Object Privileges)

Revokes object privileges from users and from roles. Reverses the action of the GRANT (Object Privileges) command.

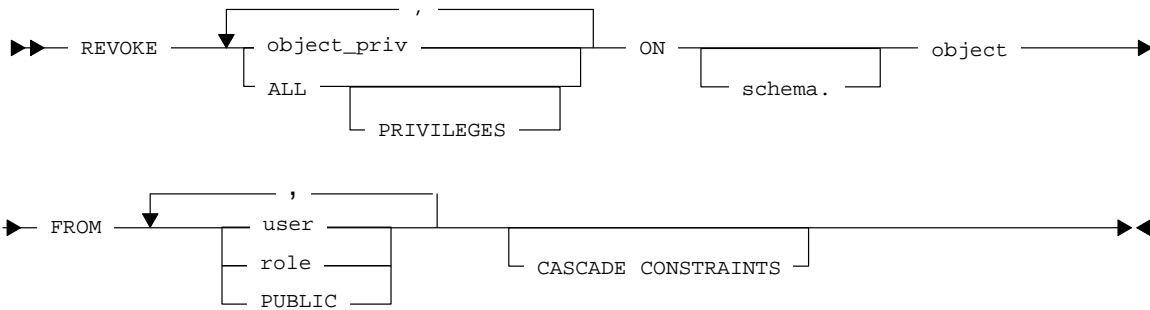

## ROLLBACK

Undoes all changes made since the savepoint. Undoes all changes in the current transaction if no savepoint is specified.

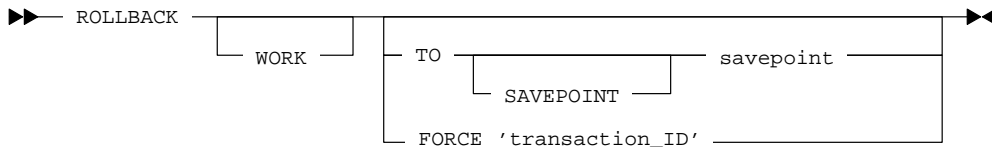

## SAVEPOINT

Identifies a savepoint in the current transaction to which changes can be rolled back.



## SELECT

Queries one or more tables or views. Returns rows and columns of data. May be used as statement or as a subquery in another statement.

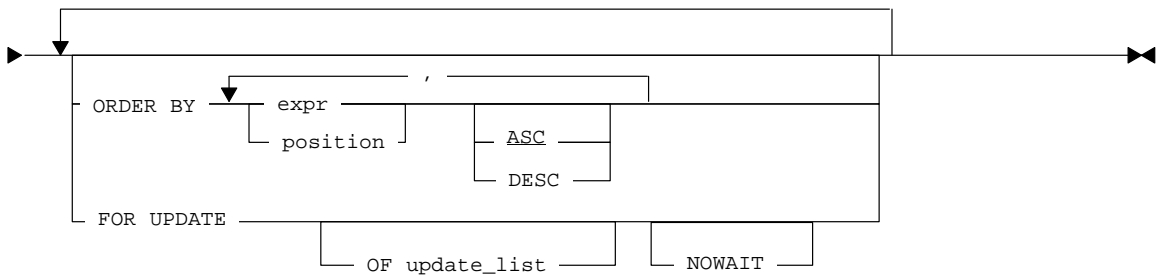
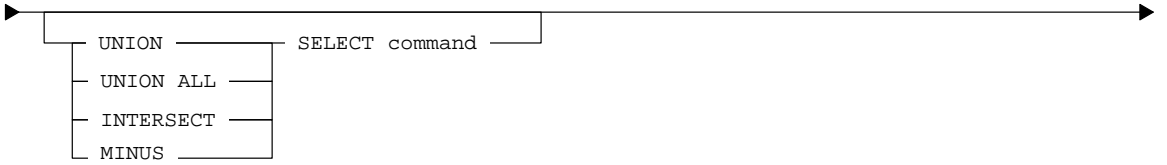
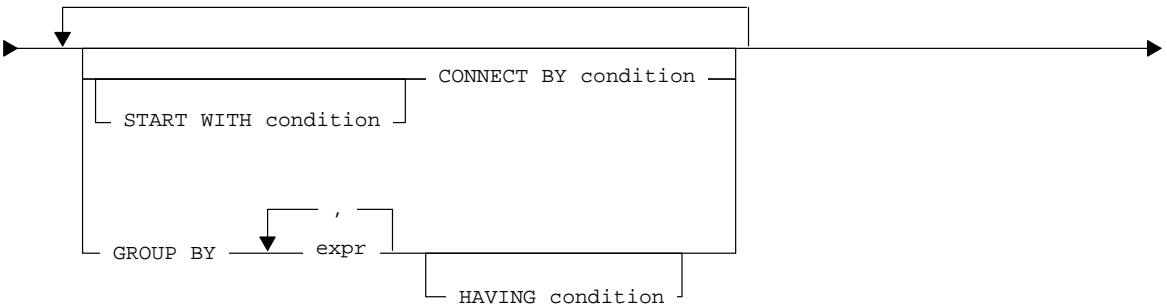
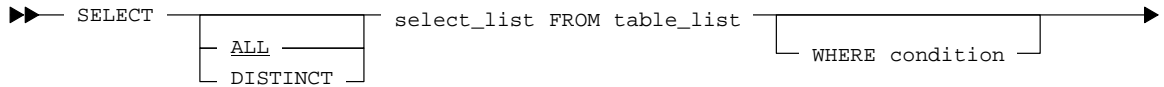

**select\_list ::=**

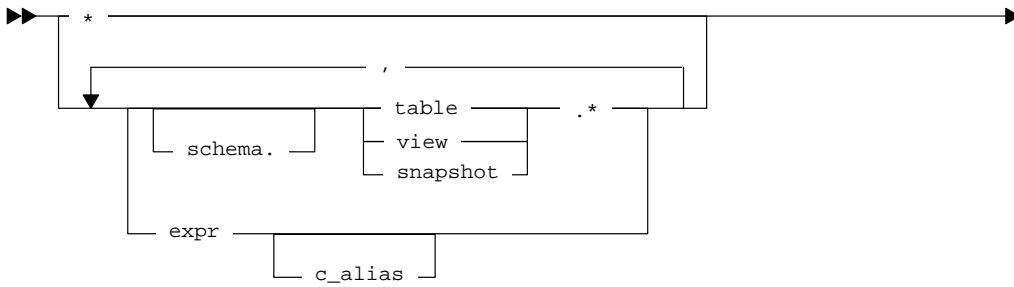

**table\_list ::=**

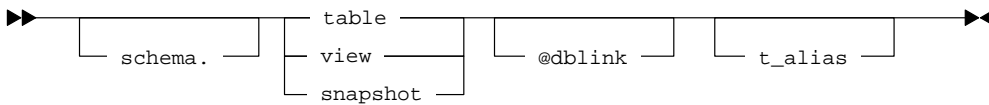

**update\_list ::=**

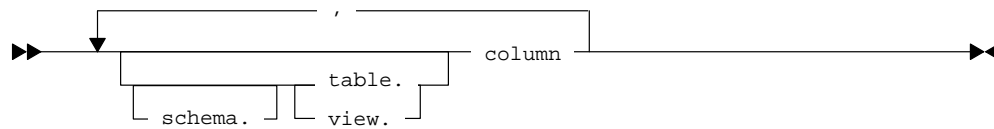

## SET ROLE

Enables a specific role for a session and disables all other roles for a user. Along with SET TRANSACTION, must be at the start of the transaction.

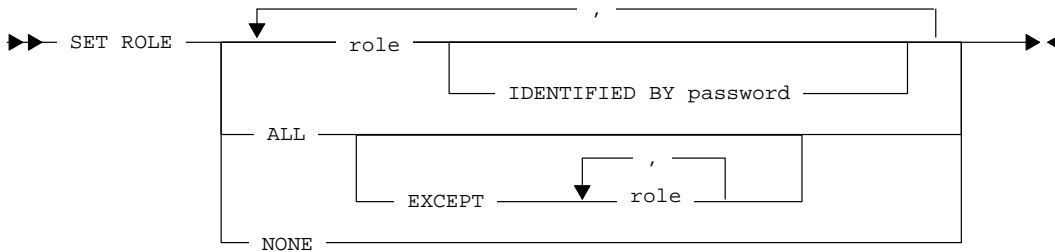

## SET TRANSACTION

Enforces read consistency at the transaction level, or specifies the rollback segment to be used for the transaction. Along with SET ROLE, must be at the start of the transaction.

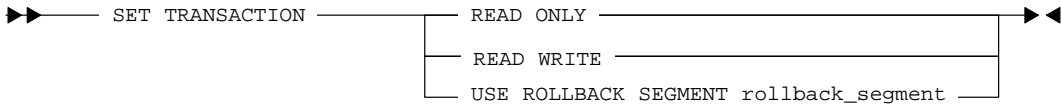

## TRUNCATE

Removes all rows from a table or cluster.

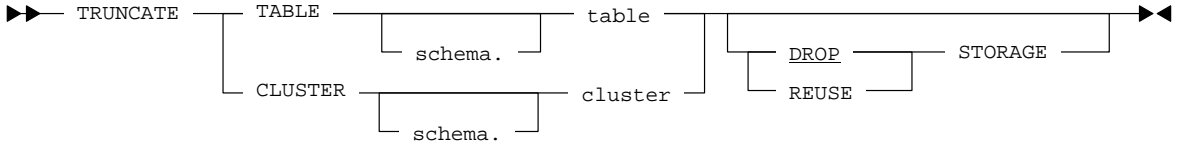

## UPDATE

Changes the values of columns in rows that meet the `WHERE` condition in a table or view. Changes all rows if no `WHERE` condition is specified.

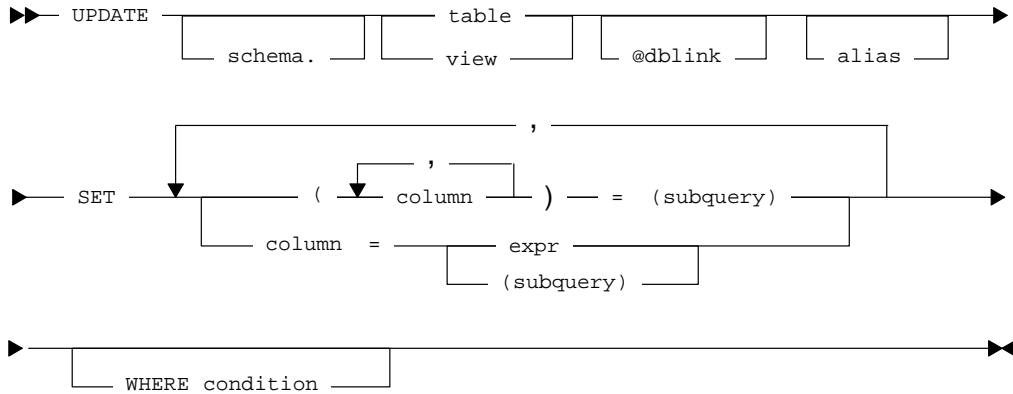

---

## Comments

Comments set off by `/*` and `*/` may appear anywhere within a SQL statement:

```
ALTER USER SCOTT /* This is a comment */
IDENTIFIED BY TIGER;
```

ANSI-standard comments may also be used. All characters from a double-hyphen to the end of the line are ignored.

```
ALTER USER SCOTT -- This comment goes to the end of the line
IDENTIFIED BY TIGER;
```

---

## Embedded SQL Commands

You can use the ORACLE precompilers to embed SQL statements into an application program. For the syntax of embedded SQL statements, refer to the SQL Language Reference Manual, Part No. 778-70.

---

## Special Tables

### CHAINED\_ROWS

#### Table

Lists chained rows in a table or cluster named in the ANALYZE command.

<i>Column</i>	<i>Datatype</i>
OWNER_NAME	VARCHAR2(30)
TABLE_NAME	VARCHAR2(30)
CLUSTER_NAME	VARCHAR2(30)
HEAD_ROWID	ROWID
TIMESTAMP	DATE

### EXCEPTIONS Table

Used to identify rows that violate integrity constraints when constraints are enabled.

<i>Column</i>	<i>Datatype</i>
ROWID	ROWID
OWNER	VARCHAR2(30)
TABLE_NAME	VARCHAR2(30)
CONSTRAINT	VARCHAR2(30)

### PLAN\_TABLE

This table may be filled in with the EXPLAIN PLAN command, to get a description of the execution plan for a SQL statement. To interpret the plan, see the *ORACLE RDBMS Performance Tuning Guide*.

<b>Column</b>	<b>Datatype</b>
STATEMENT_ID	VARCHAR2(30)
TIMESTAMP	DATE
REMARKS	VARCHAR2(80)
OPERATION	VARCHAR2(30)
OPTIONS	VARCHAR(230)
OBJECT_NODE	VARCHAR2(30)
OBJECT_OWNER	VARCHAR2(30)
OBJECT_NAME	VARCHAR(30)
OBJECT_INSTANCE	NUMBER
OBJECT_TYPE	VARCHAR2(30)
SEARCH_COLUMNS	NUMBER
ID	NUMBER
PARENT_ID	NUMBER
POSITION	NUMBER
OTHER	LONG

---

## Data Dictionary Views

The Data Dictionary contains information about database objects, users, and events. You can access this information through these views of the data dictionary:

<b>View</b>	<b>Description</b>
ALL_CATALOG	All tables, views, synonyms, and sequences accessible to the user.
ALL_COL_COMMENTS	Comments on columns of accessible tables and views.
ALL_COL_PRIVS	Synonym for COLUMN_PRIVILEGES.
ALL_COL_PRIVS_MADE	Grants on columns for which the user or PUBLIC is the grantee.
ALL_COL_PRIVS_RECD	Grants on columns for which the user or PUBLIC is the grantee.
ALL_CONSTRAINTS	Constraint definitions on accessible tables.
ALL_CONS_COLUMNS	Information about accessible columns in constraint definitions.
ALL_DB_LINKS	Database links accessible to the user.

<b>View</b>	<b>Description</b>
ALL_DEF_AUDIT_OPTS	Auditing options for newly created objects.
ALL_DEPENDENCIES	Dependencies between objects.
ALL_ERRORS	Current errors on all stored objects in the database.
ALL_INDEXES	Description of indexes on tables accessible to the user.
ALL_IND_COLUMNS	Columns of the indexes on accessible tables.
ALL_LABELS	Trusted ORACLE view that lists system labels.
ALL_COUNTED_DBS	Trusted ORACLE view that lists mounted databases.
ALL_OBJECTS	Objects accessible to the user.
ALL_SEQUENCES	Description of sequences accessible to the user.
ALL_SNAPSHOTS	All snapshots accessible to the user.
ALL_SOURCE	Text source of all stored objects in the database.
ALL_SYNONYMS	All synonyms accessible to the user.
ALL_TABLES	Description of tables accessible to the user.
ALL_TAB_COLUMNS	Columns of all tables, vies, and clusters.
ALL_TAB_COMMENTS	Comments on tables and views accessible o the user.
ALL_TAB_PRIVS	Synonym for TABLE_PRIVILEGES.
ALL_TAB_PRIVS_MADE	User's grants and grants on user's objects.
ALL_TAB_PRIVS_RECD	Grants on objects for which the user or PUBLIC is the grantee.
ALL_TRIGGERS	Triggers accessible to the current user.
ALL_USERS	Information about all users of the database.
ALL_VIEWS	Text of views accessible to the user.
AUDIT_ACTIONS	Description table for audit trail action type codes.
CAT	Synonym for USER_CATALOG
CLU	Synonym for USER_CLUSTERS.
CODE_PIECES	Used for building the _OBJECT_SIZE views.
CODE_SIZE	Used for building the _OBJECT_SIZE views.
COLS	Synonym for USER_TAB_COLUMNS.
COLUMN_PRIVILEGES	Grants on columns for which the user is the grantor, grantee, or owner, or PUBLIC is the grantee.
DBA_2PC_NEIGHBORS	Information about incoming and outgoing connections for pending transactions.
DBA_2PC_PENDING	Information about failed distributed transactions in "PREPARED" state.

<b><i>View</i></b>	<b><i>Description</i></b>
DBA_AUDIT_EXISTS	AUDit trail entries created by the AUDIT EXISTS command.
DBA_AUDIT_OBJECT	Synonym for USER_AUDIT_OBJECT.
DBA_AUDIT_SESSION	Synonym for USER_AUDIT_SESSION.
DBA_AUDIT_STATEMENT	Synonym for USER_AUDIT_STATEMENT.
DBA_AUDIT_TRAIL	Synonym for USER_AUDIT_TRAIL.
DBA_BLOCKERS	Sessions holding a lock someone wants.
DBA_CATALOG	All database tables, views, synonyms, and sequences.
DBA_CLUSTERS	Description of all clusters in the database.
DBA_CLU_COLUMN	Mapping of table columns to cluster columns.
DBA_COL_COMMENTS	COMments on columns of all tables and views.
DBA_COL_PRIVS	All grants on columns in the database.
DBA_CONSTRAINTS	Constraint definitions on accessible tables.
DBA_CONS_COLUMNS	Information about accessible columns in constraint definitions.
DBA_DATA_FILES	Information about database files.
DBA_DB_LINKS	All database links in the database.
DBA_DDL_LOCKS	All DDL locks held and requested.
DBA_DEPENDENCIES	Dependencies to and from all objects.
DBA_DML_LOCKS	All DML locks held and requested.
DBA_ERRORS	Current errors on all stored objects in the database.
DBA_EXP_FILES	Description of export files.
DBA_EXP_OBJECTS	Objects that have been incrementally exported.
DBA_EXP_VERSION	Version number of the last export session.
DBA_EXTENTS	Extents of all segments in the database.
DBA_FREE_SPACE	Free extents in all tablespace.
DBA_INDEXES	Description for all indexes in the database.
DBA_IND_COLUMNS	Columns on indexes on all tables and clusters.
DBA_LOCKS	All locks held and requested.
DBA_OBJECTS	All objects in the database.
DBA_OBJECT_SIZE	All PL/SQL objects.
DBA_OBJ_AUDIT_OPTS	AUDiting options for all tables and views.
DBA_PRIV_AUDIT_OPTS	Auditing options for privileges.
DBA_PROFILES	Profiles assigned to each user.

<b>View</b>	<b>Description</b>
DBA_ROLE_PRIVS	Description of roles granted to users and to roles.
DBA_ROLES	All roles that exist in the database.
DBA_ROLLBACK_SEGS	Description of roles granted to users and to roles.
DBA_SEGMENTS	Storage allocated for all database segments.
DBA_SEQUENCES	Description of all sequences in the database.
DBA_SNAPSHOTS	All snapshots in the database.
DBA_SNAPSHOT_LOGS	All snapshot logs in the database.
DBA_SOURCE	Text source of all stored objects in the database.
DBA_STMT_AUDIT_OPTS	Describes current system auditing options across the system and by user
DBA_SYNONYMS	All synonyms in the database.
DBA_SYS_PRIVS	description of system privileges granted to users and to roles.
DBA_TABLES	Description of all tables in the database.
DBA_TABLESPACES	Description of all tablespace in the database.
DBA_TAB_COLUMNS	Columns of all tables, views, and clusters.
DBA_TAB_COMMENTS	Comments on all tables and views in the database.
DBA_TAB_PRIVS	All grants on objects in the database.
DBA_TRIGGERS	Description of all triggers in the database.
DBA_TS_QUOTAS	Tablespace quotas for all users.
DBA_USERS	Information about all users of the database.
DBA_VIEWS	Text of all views in the database.
DBA_WAITERS	Sessions waiting for a lock.
DBMS_ALERT_INFO	Table of registered alerts.
DBMS_LOCK_ALLOCATED	Table of user allocated locks.
DEPTREE	Object dependency tree.
DICT	Synonym for DICTIONARY.
DICTIONARY	Description of data dictionary tables and views.
DICT_COLUMNS	Description of columns in data dictionary tables and views.
ERROR_COLUMNS	Description of columns in data dictionary tables and views.
GLOBAL_NAME	Database's global name.
IDEPTRREE	Indented object dependency tree.
IND	Synonym for USER_INDEXES.

<b>View</b>	<b>Description</b>
INDEX_HISTOGRAM	Index statistics from the ANALYZE INDEX VALIDATE STRUCTURE command.
INDEX_STATS	SQL* Loader direct load view.
LOADER_COL_INFO	SQL* Loader direct load view.
LOADER_CONSTRAINT_INFO	SQL* Loader direct load view.
LOADER_INDCOL_INFO	SQL* Loader direct load view.
LOADER_IND_INFO	SQL* Loader direct load view.
LOADER_PARAM_INFO	SQL* Loader direct load view.
LOADER-TAB_INFO	SQL* Loader direct load view.
LOADER_TRIGGER-INFO	SQL* Loader direct load view.
OBJ	Synonym for USER_OBJECTS.
PARSED_PIECES	Used for building the _OBJECT_SIZE views.
PARSED_SIZE	Used for building the _OBJECT_SIZE views.
PUBLIC_DEPENDENCY	Dependencies to and from objects.
RESOURCE_COST	Cost for each resource.
ROLE_ROLE_PRIVS	Information about roles granted to other roles.
ROLE_SYS_PRIVS	Information about system privileges granted to roles.
ROLE_TAB_PRIVS	Information about table privileges granted to roles.
SEQ	Synonym for USER_SEQUENCES.
SESSION_PRIVS	Privileges which are currently available to the user.
SESSION_ROLES	Roles which the user currently has enabled.
SOURCE_SIZE	Used for building the _OBJECT_SIZE views.
STMT_AUDIT_OPTION_MAP	Description table for auditing option type codes.
SYN	Synonym for USER_SYNONYMS.
SYSTEM_PRIVILEGE_MAP	Description table for system privilege codes.
TABLE_PRIVILEGES	Grants on objects for which the user is the grantor, grantee, or owner, or PUBLIC is the grantee.
TABLE_PRIVILEGE_MAP	Description table for object privilege codes.
TABS	Synonym for USER_TABLES.
USER_AUDIT_OBJECT	Audit trail records for statement concerning objects.
USER_AUDIT_SESSION	All audit trail records concerning connections and disconnections for the user.

<b>View</b>	<b>Description</b>
USER_AUDIT_STATEMENT	Audit trail entries for the following statements: grant, revoke, audit, noaudit, and ALTER SYSTEM
USER_AUDIT_TRAIL	Audit trail entries relevant to the user.
USER_CATALOG	Tables, views, synonyms, and sequences owned by the user.
USER_CLUSTERS	Description of user's own clusters.
USER_CLU_COLUMNS	Mapping of table columns to cluster columns.
USER_COL_COMMENTS	Comments on columns of user's tables or views.
USER_COL_PRIVS	Grants on columns for which the user is the owner, grantor, or grantee.
USER_COL_PRIVS_MADE	All grants on columns of objects owned by the user.
USER_COL_PRIVS_REC'D	Grants on columns for which the user is the grantee.
USER_CONSTRAINTS	Constraint definitions on user's tables.
USER_CONS_COLUMNS	Information about columns in constraint definitions owned by the user.
USER_DB_LINKS	Database links owned by the user.
USER_DEPENDENCIES	Dependencies to and from a user's objects.
USER_ERRORS	Current errors on all stored objects in the database.
USER_EXTENTS	Extents of the segments owned by the user.
USER_FREE_SPACE	Free extents in tablespace accessible to the user.
USER_INDEXES	Description of the user's own indexes.
USER_IND_COLUMNS	Columns of the user's indexes or on user's tables.
USER_OBJECTS	Objects owned by the user.
USER_OBJECT_SIZE	User's PL/SQL objects.
USER_OBJ_AUDIT_OPTS	Auditing options for user's own tables and views.
USER_RESOURCE_LIMITS	Displays the resource limits for the current user.
USER_ROLE_PRIVS	Roles granted to the user.
USER_SEGMENTS	Storage allocation for all database segments.
USER_SEQUENCES	Description of the user's own sequences.
USER_SNAPSHOTS	Snapshots the user can view.
USER_SNAPSHOT_LOGS	All snapshot logs owned by the user.
USER_SOURCE	Text source of all stored objects in the database.
USER_SYNONYMS	The user's private synonyms.
USER_SYS_PRIVS	System privileges granted to the user.

<b>View</b>	<b>Description</b>
USER_TABLES	Description of the user's own tables.
USER_TABLESPACES	Description of accessible tablespaces.
USER_TAB_COLUMNS	Columns of user's tables, views, and clusters.
USER_TAB_COMMENTS	Comments on the tables and views owned by the user.
USER_TAB_PRIVS	Grants on objects for which the user is the owner, grantor, or grantee.
USER_TAB_PRIVS_MADE	All grants on objects owned by the user.
USER_TAB_PRIVS_RECD	Grants on objects for which the user is the grantee.
USER_TRIGGERS	Description of the user's triggers.
USER_TS_QUOTAS	Tablespace quotas for the user.
USER_USERS	Information about the current user.
USER_VIEWS	Text of views owned by the user.

---

## Dynamic Performance Tables

The system performance tables are accessible to the user SYS.

<b>Table</b>	<b>Description</b>
V\$ACCESS	Describes the owners of tables.
V\$ARCHIVE	information on archive logs.
V\$BACKUP	Backup status of online data files.
V\$BGPROCESS	Describes the background processes.
V\$CIRCUITS	information on virtual circuits.
V\$DATABASE	Database information from the control file.
V\$DATAFILE	Data file information from the control file.
V\$DBFILE	information about each database file in the database.
V\$DB_OBJECT_CACHE	Shows objects cached in the library cache.
V\$DISPATCHERS	Information on the dispatcher processes.
V\$ENABLEDPRIVS	information about enabled privileges.
V\$FILESTAT	information about file read/write statistics.
V\$INSTANCE	State of the current instance.
V\$LATCH	Information about each type of latch. (The rows of this table and the rows. of V\$LATCHNAME correspond one-to-one.)

<b>Table</b>	<b>Description</b>
V\$LATCHHOLDER	Information about the current latch holders.
V\$LATCHNAME	The decoded latch names for the latches shown in table V\$LATCH. (The rows of this table and the rows of V\$LATCH correspond one-to-one.)
V\$LIBRARYCACHE	Statistics on library cache management.
V\$LICENSE	Information on license limits.
V\$LOADSTAT	SQL* Loader direct statistics.
V\$LOADSTAT	SQL* Loader direct statistics.
V\$LOCK	Information about locks and resources.
V\$LOG	Log information from the control file.
V\$LOGHIST	Log history information from the control file.
V\$LOG_HISTORY	Archived log names.
V\$LOGFILE	Information about redo log files.
V\$NLS_PARAMETERS	Current values of NLS parameters.
V\$OPEN_CURSOR	Cursors that each session has open and parsed.
V\$PARAMETER	Information about current parameter values.
V\$PROCESS	Information about currently active processes.
V\$QUEUES	Information on multi-thread message queues.
V\$RECOVERY_LOG	Archived logs needed for media recovery.
V\$RECOVER_FILE	Status of files needing media recovery.
V\$REQDIST	Status of files needing media recovery.
V\$RESOURCE	Histogram of lock request times.
V\$ROLLNAME	Information about resources.
V\$ROLLSTAT	Names of rollback segments (Although this table has no join key with V\$ROLLSTAT, the rows on the two tables correspond one-to-one.)
V\$ROWCACHE	Statistics for data dictionary activity: each row contains statistics for one data dictionary cache.
V\$SECONDARY	Trusted ORACLE view of secondary mounted databases.
V\$SESSION	Session information for each current session.
V\$SESSTAT	For each current session, the current statistics values.
V\$SESSION_WAIT	Wait status of active sessions.
V\$SESS_IO	User session I/O statistics.

<b>Table</b>	<b>Description</b>
V\$SGA	Information about the System Global Area.
V\$SGASTAT	Detailed statistics on the SGA.
V\$SHARED_SERVERS	Information on shared server processes.
V\$SQLAREA	Statistics on the shared cursor cache.
V\$SQLTEXT	Full text of cached SQL statements.
V\$STATNAME	Decoded statistic names for the statistics.
V\$SYSLABEL	Trusted ORACLE view of system labels.
V\$SYSSTAT	The current system-wide value for each statistic in table V\$SESSTAT.
V\$THREAD	Thread information from the control file.
V\$TIMER	Current time in hundredths of seconds.
V\$TRANSACTION	Information about transactions.
V\$TYPE_SIZE	Sizes of database components.
V\$VERSION	Versions of core library components.
V\$WAISTAT	Block contention statistics.

---

## **Reader's Comment Form**

### **ORACLE7 Server SQL language Quick Reference**

-Part Np. 5421-70-1292

December 1993

Oracle Corporation welcomes your comments and suggestions on the quality and usefulness of this publication. Your input is an important part of the information used for revision.

- Did you find any errors?
- In the information clearly presented?
- Do you need more information? If so, where?
- Are the examples correnct? Do you need more examples?
- What features did you like most about this manual?

If you find any errors or have any other suggestions for improvement, please indicate the topic, chapter and page number below:

---

---

---

---

---

---

---

Please mail or FAX your comments to:  
ORACLE7 Server Documentaiton Manager  
Oracle Corporation  
500 Oracle Parkway  
Redwood Shores, CA 94065  
(415) 506-7000

FAX: (415) 506-7200

If you would like a reply, please give your name, address, and telephone number below:

---

---

---

---

Thank you for helping us improve our documentation.