

ESP8266 SDK

Getting Started Guide



Version 3.4
Espressif Systems
Copyright © 2020

About This Guide

This document takes ESP-LAUNCHER and ESP-WROOM-02 as examples to introduce how to use the ESP8266 SDK V2.X and earlier versions. The contents include preparations before compilation, SDK compilation and firmware download.

For the new ESP8266_RTOS_SDK (ESP-IDF style) V3.0 and later versions, please see [ESP8266_RTOS_SDK/docs](#).

Release Notes

Date	Version	Release notes
2016.04	V2.0	First release.
2016.07	V2.1	Added MXIC Flash QIO mode; Modified the default value of byte 112 to 0.
2016.07	V2.2	Updated Section 3.3.1.
2016.08	V2.3	Updated the Baidu link in Section 3.3.1.
2016.10	V2.4	Updated the flash address of <i>eagle.irom0.text.bin</i> in Section 4.1.1.
2016.11	V2.5	Added Appendix B—Learning Resources.
2017.01	V2.6	Modified the default value of byte 113 to 0 in Table 6-6. Added two Github links of RTOS and non-OS SDK sample code in Appendix B.2—Must-Have Resources.
2017.02	V2.7	Updated sections 3.1 and 3.2; Updated the link for the OVA image file in section 3.3.1; Updated Section 5.1.2.
2017.05	V2.8	Updated Chapter 4 for 8 MB and 16 MB flash support.
2017.11	V2.9	Updated Table 1-1 in Chapter 1; Updated Figure 4-1 and the parameter descriptions in Chapter 4; Updated Table 4-1, Table 4-2, Table 4-3 and Table 4-4 in Chapter 4.
2018.03	V3.0	Updated section 4.1.1; Updated Table 4-1 in Chapter 4.
2018.06	V3.1	Updated Table 4-3 in Chapter 4.2.1.
2019.02	V3.2	Updated the description in Appendix A; Updated the document format.
2019.12	V3.3	Updated the description of ESP8266_RTOS_SDK (ESP-IDF style) V3.0 and later versions in About this Guide.
2020.09	V3.4	Removed section 6.3; Removed some obsolete links.

Documentation Change Notification

Espressif provides email notifications to keep customers updated on changes to technical documentation. Please subscribe at <https://www.espressif.com/en/subscribe>.

Certification

Download certificates for Espressif products from <https://www.espressif.com/en/certificates>.

Table of Contents

1. Overview	1
1.1. Procedure Overview	1
1.2. ESP8266 HDK	1
1.3. ESP8266 SDK	2
1.3.1. Non-OS SDK.....	2
1.3.2. RTOS SDK	2
1.4. ESP8266 FW	2
1.5. ESP8266 Toolkit	3
1.5.1. Compiler	3
1.5.2. Firmware Download Tool	3
1.5.3. Serial Port Debug Tool.....	3
2. Preparing the Hardware	5
2.1. ESP-LAUNCHER.....	5
2.2. ESP-WROOM-02	6
3. Preparing the Software.....	8
3.1. Non-OS SDK	8
3.2. RTOS SDK	8
3.3. ESP8266 Toolkit	10
3.3.1. Compiler	10
3.3.2. Firmware Download Tool	12
4. Flash Maps.....	13
4.1. Non-OTA	14
4.1.1. Flash Map	14
4.1.2. Download Addresses.....	15
4.2. OTA Firmware.....	15
4.2.1. Flash Map	15
4.2.2. Download Addresses.....	16
5. Compiling the SDK	17
5.1. Preparations	17
5.1.1. Modifying SDK Files	17

5.1.2. Downloading SDK Files	18
5.2. Compilation	19
5.2.1. Compile ESP8266_NONOS_SDK_v0.9.5 and Later Versions	19
5.2.2. ESP8266_NONOS_SDK_v0.9.4 and Earlier Versions	20
6. Downloading the Firmware	21
6.1. Download Procedure	21
6.2. Check Log File	23
6.2.1. ESP8266 IOT Demo.....	23
6.2.2. ESP8266 AT	24
A. Appendix—Configuring Flash DIO to QIO Mode.....	25
B. Appendix—Learning Resources	26
B.1. Must-Read Documents	26
B.2. Must-Have Resources.....	26



1.

Overview

1.1. Procedure Overview

Figure 1-1 shows the overall procedure of the SDK compilation.

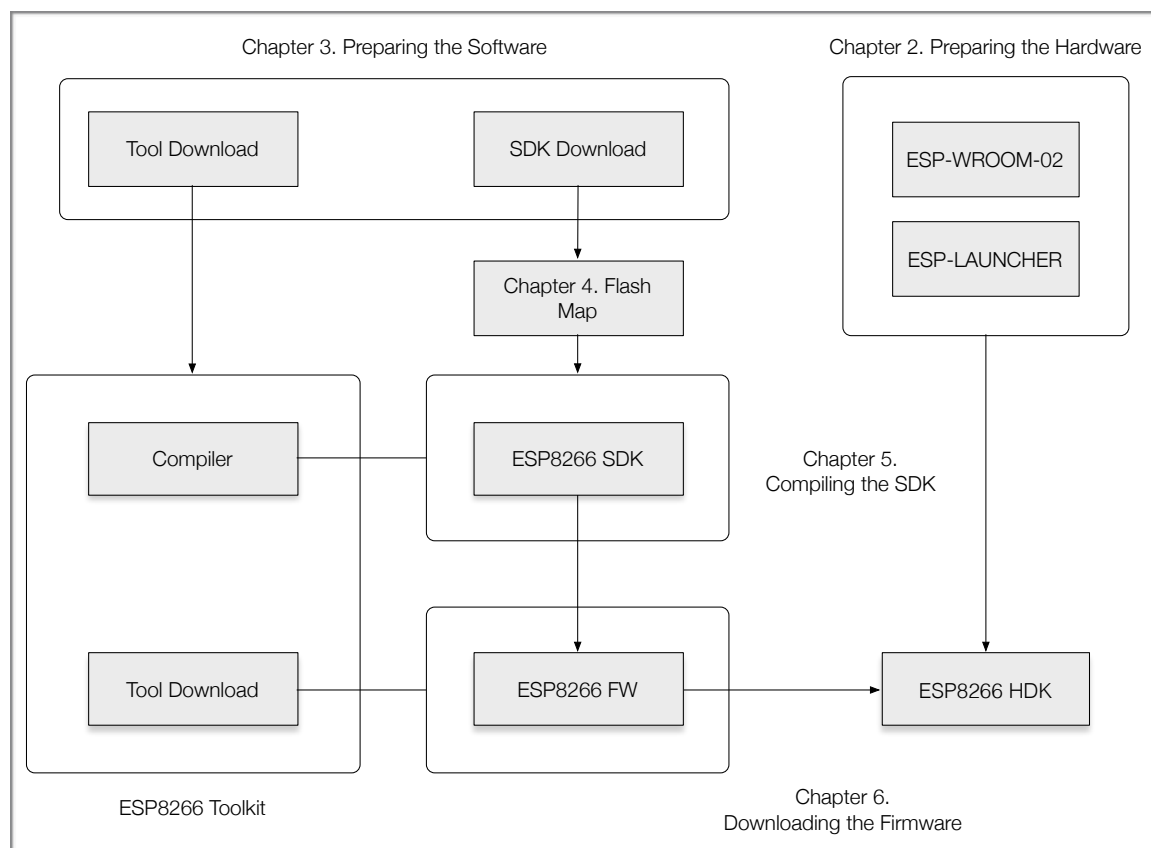

Figure 1-1 Procedure Overview

1.2. ESP8266 HDK

The ESP8266 HDK (Hardware Development Kit) includes the chip—ESP8266EX, the module—ESP-WROOM-02 and the development board—ESP-LAUNCHER. Users can download the pre-compiled firmware using ESP-WROOM-02 or ESP-LAUNCHER.

Notes:

- If users use other development boards or modules that integrate ESP8266EX, please use the development firmware provided by the corresponding manufacturers.
- If users would like to purchase ESP-WROOM-02 or ESP-LAUNCHER, please visit Espressif's official online store at: <https://espressif.taobao.com>.



1.3. ESP8266 SDK

The ESP8266 Software Development Kit (SDK) is an Internet of Things (IoT) application development platform developed by Espressif for developers. It includes such examples of application development as Smart Lights and Smart Plugs.

Depending on whether they are based on an operating system (OS), SDKs can be categorized into two types: Non-OS SDK and RTOS SDK.

1.3.1. Non-OS SDK

Non-OS SDK is not based on an operating system. It supports the compilation of IOT_Demo and AT commands. Non-OS SDK uses timers and callbacks as the main way to perform various functions such as nested events and functions triggered by certain conditions. Non-OS SDK uses the espconn network interface; users need to develop their software according to usage rules of the espconn interface.

1.3.2. RTOS SDK

RTOS SDK is based on FreeRTOS, open-source software development on Github.

- The FreeRTOS SDK is based on FreeRTOS, a multi-tasking OS. Users can use standard interfaces to realize resource management, recycling operations, execution delays, inter-task messaging and synchronization, and other task-oriented process design approaches. For the specifics of interface methods, please refer to the official website of FreeRTOS or USING THE FreeRTOS REAL TIME KERNEL—A Practical Guide
- The network operation interface in RTOS SDK is the standard lwIP API. RTOS SDK provides a package which enables a BSD Socket API interface. Users can directly use the socket API to develop software applications; and port to ESP8266 other applications from other platforms using the socket API, effectively reducing the learning costs arising from switching platforms.
- RTOS SDK introduces cJSON library whose functions make it easier to parse JSON packets.
- RTOS is compatible with non-OS SDK in Wi-Fi interfaces, SmartConfig interfaces, Sniffer related interfaces, system interfaces, timer interfaces, FOTA interfaces and peripheral driver interfaces, but does not support AT implementation.

1.4. ESP8266 FW

ESP8266 FW (Firmware) has been provided in binary format files (.BIN) that can be downloaded directly to the HDK. Users can choose between Over-The-Air (OTA) and non-OTA firmware. For detailed information, please refer to Table 1-1.



Table 1-1. ESP8266 FW

Binaries	Compulsory or optional	Description	Non-OTA	OTA
<i>esp_init_data_default.bin</i>	Compulsory	Default system parameters provided in SDK.	✓	✓
<i>blank.bin</i>	Compulsory	Default system parameters provided in SDK.	✓	✓
<i>eagle.flash.bin</i>	Compulsory	Main program compiled from SDK.	✓	✗
<i>eagle.irom0text.bin</i>	Compulsory	Main program compiled from SDK.	✓	✗
<i>boot.bin</i>	Compulsory	Bootloader provided in SDK.	✗	✓
<i>user1.bin</i>	Compulsory for first usage	Main program compiled from SDK.	✗	✓
<i>user2.bin</i>	Used in firmware upgrade	Main program compiled from SDK.	✗	✓

Notes:

- For the contents of SDK, please refer to Chapter 3, "Preparing the Software".
- For SDK compilation, please refer to Chapter 5, "Compiling the SDK".
- For the addresses of binaries in the flash, please refer to Chapter 4, "Flash Maps".

1.5. ESP8266 Toolkit

1.5.1. Compiler

Linux OS is required to compile the ESP8266 SDK. When using Windows OS, we recommend VirtualBox as the virtual machine for ESP8266. In order to simplify the compilation procedure, we have installed the compiling tools on the virtual machine. Users can directly compile the ESP8266 SDK by importing the ESP8266 compiler (OVA image) into the virtual machine.

1.5.2. Firmware Download Tool

The ESP8266 DOWNLOAD TOOL is the official firmware download tool developed by Espressif. Users can download multiple binaries to the SPI Flash of the ESP8266 mother board (ESP-LAUNCHER or ESP-WROOM-02) at the same time according to the actual compilation mode and flash size.

1.5.3. Serial Port Debug Tool

The serial port debug tool can be used to directly communicate with the ESP8266 module over a standard RS-232 port. For PCs that do not have a physical serial port, a virtual com port (USB-to-serial converter) can be used.



Users may directly input commands into the terminal and view or record responses in real time.

 **Note:**

We recommend CoolTerm (for Windows and Mac OS) and Minicom (for Linux OS) as the serial port debug tool.



2. Preparing the Hardware

Depending on whether the ESP-LAUNCHER or the ESP-WROOM-02 is used, users will need either of the hardware mentioned in Table 2-1 below:

Table 2-1. Hardware Preparations

ESP-LAUNCHER	ESP-WROOM-02
<ul style="list-style-type: none"> • 1 × ESP-LAUNCHER • 1 × USB cable 	<ul style="list-style-type: none"> • 1 × ESP-WROOM-02 • 1 × USB-to-TTL converter (FT232R recommended) • 6 × Dupont lines • 1 × soldering tool suite

1 × PC with pre-installed Windows OS

! Notice:

The ESP8266 Wi-Fi module needs a 3.3V power supply and may draw a minimum current of 500 mA.

2.1. ESP-LAUNCHER

1. Connect PC to the USB-UART interface of ESP-LAUNCHER using the USB cable.
2. Set ESP-LAUNCHER to download mode.

Steps	Result
<ul style="list-style-type: none"> • Slide Power Switch towards the outer side as the figure on the right shows. • Slide GPIO0 Control towards the inner side to enable ESP-LAUNCHER's download mode. <p>! Notice: J82 must be shorted by a jumper, otherwise code cannot be downloaded to the board.</p>	



3. Connect the USB-to-TTL converter to the PC.

Note:

Make sure that the proper driver for the USB-to-TTL converter is installed and recognized by the PC.

4. Power on ESP-LAUNCHER by sliding the Power Switch towards the inner side.
5. Power on the chip by sliding the Chip Switch towards the outer side.
6. Download firmware to flash with the ESP8266 DOWNLOAD TOOL.

Note:

On how to download firmware, please refer to Chapter 4, "Flash Map" and Chapter 6, "Downloading the Firmware".

7. After downloading, slide the GPI00 Control towards the outer side to enable ESP-LAUNCHER's working mode.
8. Power on the chip again with the Chip Switch and the chip will read and run programs from the flash.

2.2. ESP-WROOM-02

1. Lead out the pins of the ESP-WROOM-02, as shown in Table 2-2.

Table 2-2. ESP-WROOM-02 Pins

Pin	Pin status	Figure
EN	Pull up	
3V3	3.3V power supply (VDD)	
IO15	Pull down	
IO0	UART download: pull down; Flash boot: floating/pull up	
GND	GND	
RXD	Receive-end in UART download	
TXD	Transmit-end in UART download; floating/pull up	

2. Connect ESP-WROOM-02 to the USB-to-TTL converter, using Dupont lines, as shown in Figure 2-1.

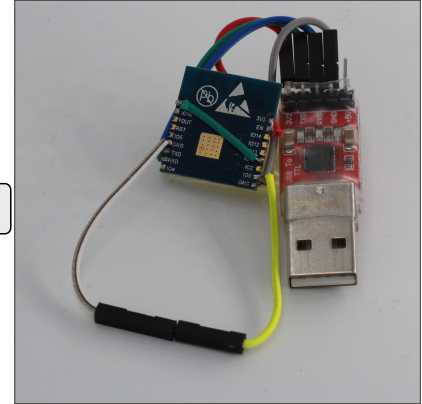
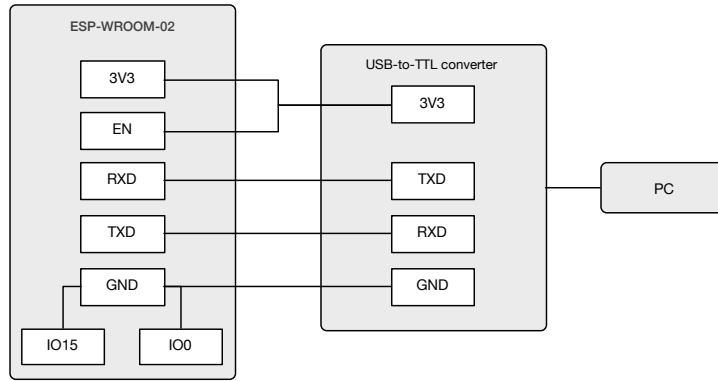

Figure 2-1. ESP-WROOM-02 Download Mode

3. Connect the USB-to-TTL converter to the PC.
4. Download firmware to flash with the ESP8266 DOWNLOAD TOOL.

Note:

On how to download firmware, please refer to Chapter 4, "Flash Maps" and Chapter 6, "Downloading the Firmware".

5. After downloading, switch ESP-WROOM-02 to working mode.
Set IO0 as floating or pull-up.
6. Power on ESP-LAUNCHER again and the chip will read and run programs from the flash.

←
END

Notes:

- IO0 is an internal pull-up pin.
- For more information on ESP-WROOM-02 hardware, please refer to [ESP-WROOM-02 Datasheet](#).



3. Preparing the Software

3.1. Non-OS SDK

Users can download the non-OS SDK (including application examples) from:
http://www.espressif.com/en/support/download/sdks-demos?keys=&field_type_tid%5B%5D=14.

Figure 3-1 shows the directory structure of the non-OS SDK.

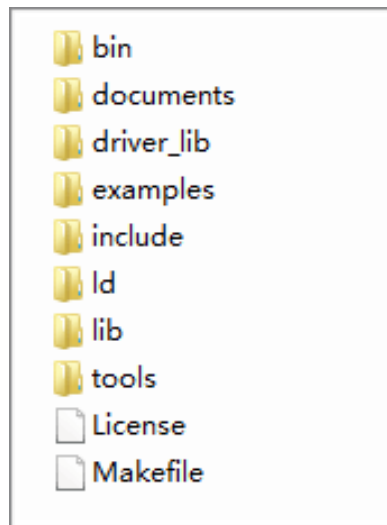

Figure 3-1. Non-OS SDK Directory Structure

- **bin**: compiled binaries to be downloaded directly into the flash.
- **documents**: SDK-related documents or links.
- **driver_lib**: library files that drive peripherals, such as UART, I2C and GPIO.
- **examples**: sample codes for secondary development, for example, IoT Demo.
- **include**: header files pre-installed in SDK. The files contain relevant API functions and other macro definitions. Users do not need to modify them.
- **ld**: linker scripts. We suggest users not modifying them without any specific reasons.
- **lib**: library files provided in SDK.
- **tools**: tools needed for compiling binaries. Users do not need to modify them.

3.2. RTOS SDK

Users can download RTOS SDK and its application examples from:

- RTOS SDK
https://github.com/espressif/ESP8266_RTOS_SDK

Table 3-2 shows the directory structure of the RTOS SDK.

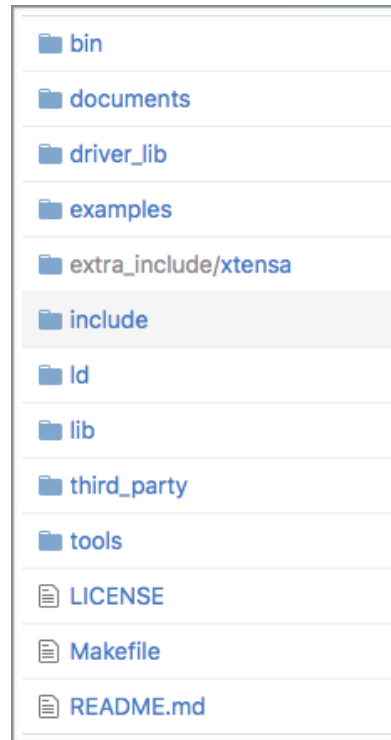

Figure 3-2. RTOS SDK Directory Structure

- **bin**: boot and initialization firmware.
- **documents**: ESP8266_RTOS_SDK files.
- **driver_lib**: sample codes of drivers.
- **examples**: sample codes for Espressif's application programs.
 - **openssl_demo**: sample codes of the openssl API function.
 - **project_template**: sample codes of project templates.
 - **smart_config**: sample codes of SmartConfig.
 - **spiffs_test**: sample codes of the spiffs file system function.
 - **websocket_demo**: sample codes of web socket.
- **include**: header files of ESP8266_RTOS_SDK, including software interfaces and macro functions for users to use.
- **ld**: link files used when compiling; users do not need to modify them.
- **lib**: library file of ESP8266_RTOS_SDK.
- **third_party**: third-party library of Espressif's open-source codes, currently including free RTOS, JSON, lwIP, mbedTLS, noPoll, OpenSSL, spiffs, and SSL.
- **tools**: tools needed for compiling binaries; users do not need to modify them.



3.3. ESP8266 Toolkit

3.3.1. Compiler

Please download VirtualBox from: <https://www.virtualbox.org/wiki/Downloads>.

Note:



Please choose the right version of VirtualBox according to the host machine's OS.

Please download the compiler **ESP8266_lubuntu_20141021.ova** from:

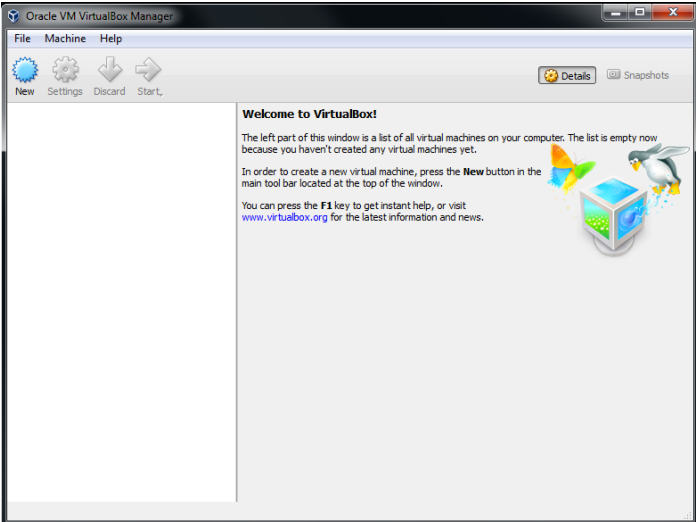

http://downloads.espressif.com/FB/ESP8266_GCC.zip

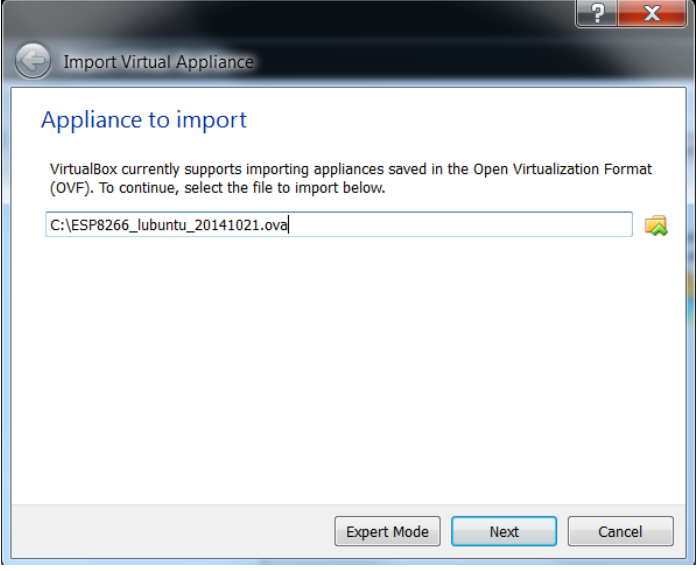
Steps	Results
<p>1. Start Windows OS and install the virtual machine.</p> <ul style="list-style-type: none">Double-click VirtualBox-5.0.16-105871-Win.exe and install VirtualBox. <p>Note:</p> <p><i>VirtualBox has different versions. We are using Windows V.5.0.16 as an example.</i></p> <ul style="list-style-type: none">Double-click Oracle VM VirtualBox.exe to run the program, and the system will show the main menu . <p>Tip:</p> <p><i>The ESP8266 virtual machine takes up much space (memory). Please reserve enough space for it.</i></p>	
<p>2. Import the image file.</p>	

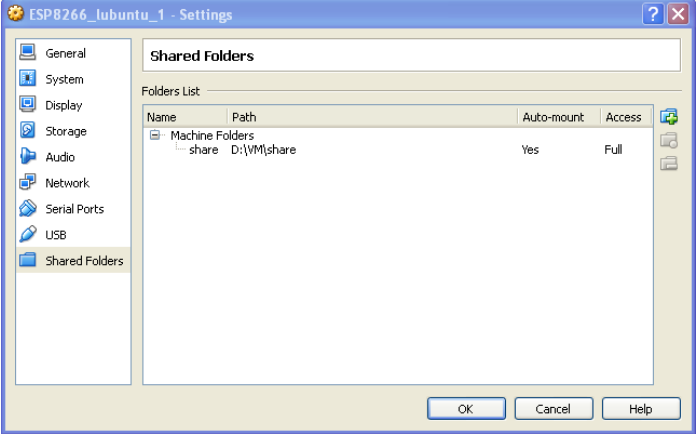

Steps	Results
<ul style="list-style-type: none">• Select File > Import Appliance, and a dialog box will show up .• Select the image file to import, for example, C:\ESP8266_lubuntu_20141021.ova, and click Next.• Click Import to confirm the settings.	
3. Create a shared folder.	
<ul style="list-style-type: none">• Create a new folder named D: VMshare.• Select Machine > Settings > Shared Folders..., and a dialog box will show up .• Select the shared folder in Machine Folders, for example, D: VMshare.	
4. Run the virtual machine.	

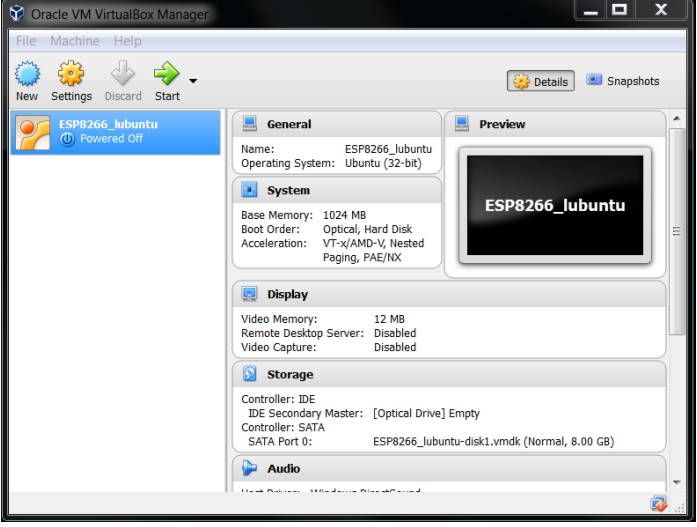

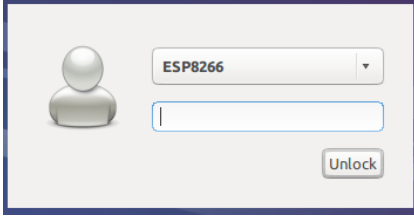
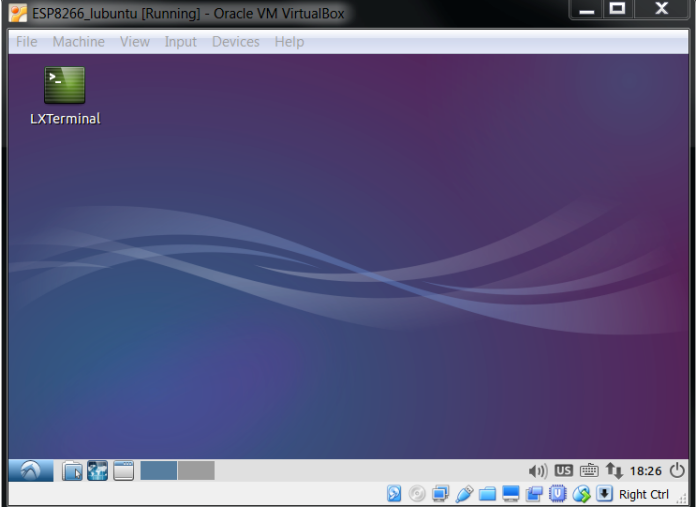
Steps	Results
<ul style="list-style-type: none">• After importing, a virtual machine named <i>ESP8266_lubuntu</i> shows up .• Double-click <i>ESP8266_lubuntu</i> or Start to run the virtual machine.	
<ul style="list-style-type: none">• The system shows the ESP8266 virtual machine .• If a dialog box like the one below  shows up, please enter the password: espressif. 	

3.3.2. Firmware Download Tool

Please download the ESP8266 DOWNLOAD TOOL from:

<http://www.espressif.com/support/download/other-tools>.



4.

Flash Maps

This chapter provides the flash maps for OTA firmware and non-OTA firmware in flash memories with a different capacity. Users can modify the map as needed.

Figure 4-1 shows the flash maps for the two different types of firmware.

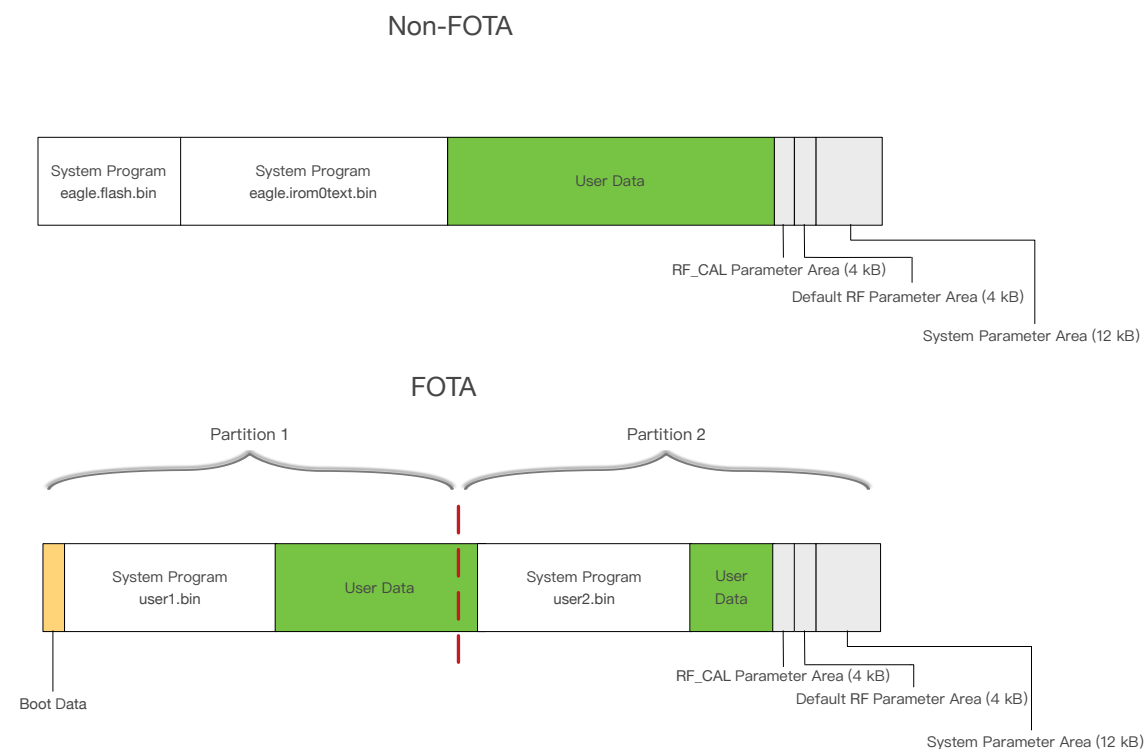

Figure 4-1. Flash Maps

Note:

For ESP8266 firmware, please refer to Section 1.3, "ESP8266 FW".

- **System Program:** This area stores the firmware necessary for the system to run.
- **User Data:** If the system data do not take up all the flash memory, the remaining area can be used to store user data. It is recommended that the user reserve at least 12 KB in the user data area to store user parameters.
- **RF_CAL Parameter:** The system automatically stores the calibrated RF parameters in this area.
- **Default RF Parameter:** Download esp_int_data_default.bin in this area to store the default RF parameters.
- **System Parameter Area:** This area stores the system parameters.
- **Boot Data:** It is located in Partition 1 of the FOTA firmware, and stores boot data.

**Notes:**

- Each sector of the flash is 4 KB.
- For detailed download addresses, please refer to the following sections..

4.1. Non-OTA

4.1.1. Flash Map

Users can change the limit by modifying *ESP8266_NONOS_SDK/ld/eagle.app.v6.ld*.

Users can modify the `len` field in `iram0_0_seg`, as shown in Figure 4-2 (red rectangle).

The location of *iram0.text* varies across different versions of SDK. Users must consult the *eagle.app.v6.ld* file and ensure that they are downloading *eagle.iram0.text.bin* to the correct offset in the flash. The address in the blue rectangle marks the location of *eagle.iram0.text.bin* in the flash.

```
MEMORY
{
  dport0_0_seg :          org = 0x3FF00000, len = 0x10
  dram0_0_seg  :          org = 0x3FFE8000, len = 0x14000
  iram1_0_seg  :          org = 0x40100000, len = 0x8000
  iram0_0_seg  :          org = 0x40210000, len = 0x5C000
}
```

Figure 4-2. Location for *iram0.text*

Table 4-1 shows the storage limits of *eagle.iram0text.bin* with different `len` values.

Table 4-1. Non-OTA Flash Map (unit: KB)

Flash capacity	eagle.flash.bin	eagle.iram0text.bin	User data	len	RF_CAL parameter	Default parameter	System parameter
512	≤ 64	≤ 368	≥ 60	0x5C000	4	4	12
1024	≤ 64	≤ 752	≥ 176	0xBC000	4	4	12
2048	≤ 64	≤ 768	≥ 176	0xC0000	4	4	12
4096	≤ 64	≤ 768	≥ 176	0xC0000	4	4	12
8192	≤ 64	≤ 768	≥ 176	0xC0000	4	4	12
16*1024	≤ 64	≤ 768	≥ 176	0xC0000	4	4	12

Note:

ESP8266 presently only supports a System Param area of up to 1024 KB.



4.1.2. Download Addresses

Table 4-2 lists the download addresses for non-OTA firmware.

Table 4-2. Download Address for Non-OTA Firmware (unit: KB)

Binaries	Download addresses in flash with different capacities					
	512	1024	2048	4096	8192	16*1024
<i>blank.bin</i>	0x7B000	0xFB000	0x1FB000	0x3FB000	0x7FB000	0xFFB000
<i>esp_init_data_default.bin</i>	0x7C000	0xFC000	0x1FC000	0x3FC000	0x7FC000	0xFFC000
<i>blank.bin</i>	0x7E000	0xFE000	0x1FE000	0x3FE000	0x7FE000	0xFFE000
<i>eagle.flash.bin</i>	0x00000					
<i>eagle.irom0text.bin</i>	0x10000					

Notes:

- In general, [ESP Flash Download Tool](#) can be used to download firmware into flash. It is recommended that the user start from the lower bits when downloading the firmware.
- But for 8 MB or 16 MB flash, please use [esptool](#) instead.

4.2. OTA Firmware

4.2.1. Flash Map

Table 4-3 lists the download addresses for the OTA firmware.

Table 4-3. OTA Flash Map (unit: KB)

Flash capacity	boot	user1.bin	user2.bin	RF_CAL parameter	Default parameter	System parameter	User data
512	4	≤ 232	≤ 232	4	4	12	≥ 0
1024	4	≤ 488	≤ 488	4	4	12	≥ 0
2048 (Partition 1 = 512)	4	≤ 488	≤ 488	4	4	12	≥ 1024
2048 (Partition 1 = 1024)	4	≤ 1000	≤ 1000	4	4	12	≥ 0
4096 (Partition 1 = 512)	4	≤ 488	≤ 488	4	4	12	≥ 3072
4096 (Partition 1 = 1024)	4	≤ 1000	≤ 1000	4	4	12	≥ 2048



Flash capacity	boot	user1.bin	user2.bin	RF_CAL parameter	Default parameter	System parameter	User data
8192 (Partition 1 = 1024)	4	≤ 1000	≤ 1000	4	4	12	≥ 6144
16384 (Partition 1 = 1024)	4	≤ 1000	≤ 1000	4	4	12	≥ 14336

4.2.2. Download Addresses

Table 4-4 lists the download addresses for the OTA firmware.

Table 4-4. Download Addresses for OTA Firmware (unit: KB)

Binaries	Download addresses in flash with different capacities							
	512	1024	2048		4096		8192	16384
			512+512	1024+1024	512+512	1024+1024	1024+1024	1024+1024
blank.bin	0x7B000	0xFB000	0x1FB000		0x3FB000		0x7FB000	0xFFB00
esp_init_data_default.bin	0x7C000	0xFC000	0x1FC000		0x3FC000		0x7FC000	0xFFC000
blank.bin	0x7E000	0xFE000	0x1FE000		0x3FE000		0x7FE000	0xFFE000
boot.bin	0x00000							
user1.bin	0x01000							
user2.bin	0x41000	0x81000	0x81000	0x101000	0x81000	0x101000	0x101000	0x101000

Notes:

- In general, [ESP Flash Download Tool](#) can be used to download firmware into flash. It is recommended that the user start from the lower bits when downloading the firmware.
- But for 8 MB or 16 MB flash, please use [esptool](#) instead.
- For OTA firmware, users do not need to download **user2.bin**, but upgrade the firmware via the cloud server.



5.

Compiling the SDK

Notes:

- This chapter demonstrates how to compile the SDK by taking `ESP8266_NONOS_SDK/examples/IoT_Demo` as an example.
- `IoT_Demo` defines three types of devices, i.e., `LIGHT_DEVICE`, `PLUG_DEVICE` and `SENSOR_DEVICE` in `examples>IoT_Demo/include/user_config.h`. Users can only configure one device at a time. The default device for configuration is `LIGHT_DEVICE`.

5.1. Preparations

5.1.1. Modifying SDK Files

Note:

Users need to modify the SDK files if using the OTA firmware.

1. Start Windows OS.
2. Modify files in `ESP8266_NONOS_SDK/examples/IoT_Demo/include` according to the flash map.
 - Modify `#define PRIV_PARAM_START_SEC` in `user_light.h` and `user_plug.h`.

```
/* NOTICE !!! ---this is for 512KB spi flash.*/
/* You can change to other sector if you use other size spi flash. */
/* Refer to the documentation about OTA support and flash mapping*/
#define PRIV_PARAM_START_SEC      0x3C
#define PRIV_PARAM_SAVE          0
```

- Modify `#define ESP_PARAM_START_SEC` in `user_esp_platform.h`.

```
/* NOTICE---this is for 512KB spi flash.
 * you can change to other sector if you use other size spi flash. */
#define ESP_PARAM_START_SEC      0x3D
```

Table 5-1 lists the modified values.

Table 5-1. Modify the Field Values in the "include" File (unit: kB)

Default value (512)	Modified values							
	512	1024	2048 (512+512)	2048 (1024+1024)	4096 (512+512)	4096 (1024+1024)	8192 (1024+1024)	16384 (1024+1024)
0x3C	-	0x7C	0x7C	0xFC	0x7C	0xFC	0xFC	0xFC
0x3D	-	0x7D	0x7D	0xFD	0x7D	0xFD	0xFD	0xFD

**Note:**

Users need not modify the SDK files if using a 512-KB flash.

5.1.2. Downloading SDK Files

1. Start Linux OS.
2. Run LXTerminal on the desktop of the virtual machine.
3. Copy the files to be compiled to the shared folder.

Steps	Results
<ul style="list-style-type: none"> • Copy ESP8266_NONOS_SDK folder to the shared directory, for example, C:\VM\share. • Copy IoT_Demo folder to C:\VM\share\ESP8266_NONOS_SDK, as shown in the figure on the right ➡. 	

4. Download shared directory.

Steps	Results
<ul style="list-style-type: none"> • Execute <code>./mount.sh</code>. • Input the password: espressif. Downloading shared files is completed. • Open the shared directory ESP8266_NONOS_SDK in the virtual machine and confirm whether the download has been successful. <ul style="list-style-type: none"> - If successful, the directory contains such files as those in the figure on the right ➡. - If not, the directory will be empty, and users will need to go over this step again. 	

Notice:

If users use the RTOS SDK, please continue with the following steps; if use the non-OS SDK, please skip Step 5.

5. Set the variable PATH to point to SDK and binaries.

```
export SDK_PATH=~/.Share/ESP8266_RTOS_SDK
export BIN_PATH=~/.Share/ESP8266_RTOS_SDK/bin
```

**Note:**

Users can add it to `.bashrc` file, otherwise Step 5 needs to be repeated each time the compiler is restarted.

5.2. Compilation

5.2.1. Compile ESP8266_NONOS_SDK_v0.9.5 and Later Versions

1. Switch to the `/Share/ESP8266_NONOS_SDK/IoT_Demo` directory in the terminal.

```
cd /home/esp8266/Share/ESP8266_NONOS_SDK/IoT_Demo
./gen_misc.sh
```

The system shows the following information:

```
gen_misc.sh version 20150511
```

Please follow below steps(1-5) to generate specific bin(s):

2. Select the required options as shown in Figure 5-1.

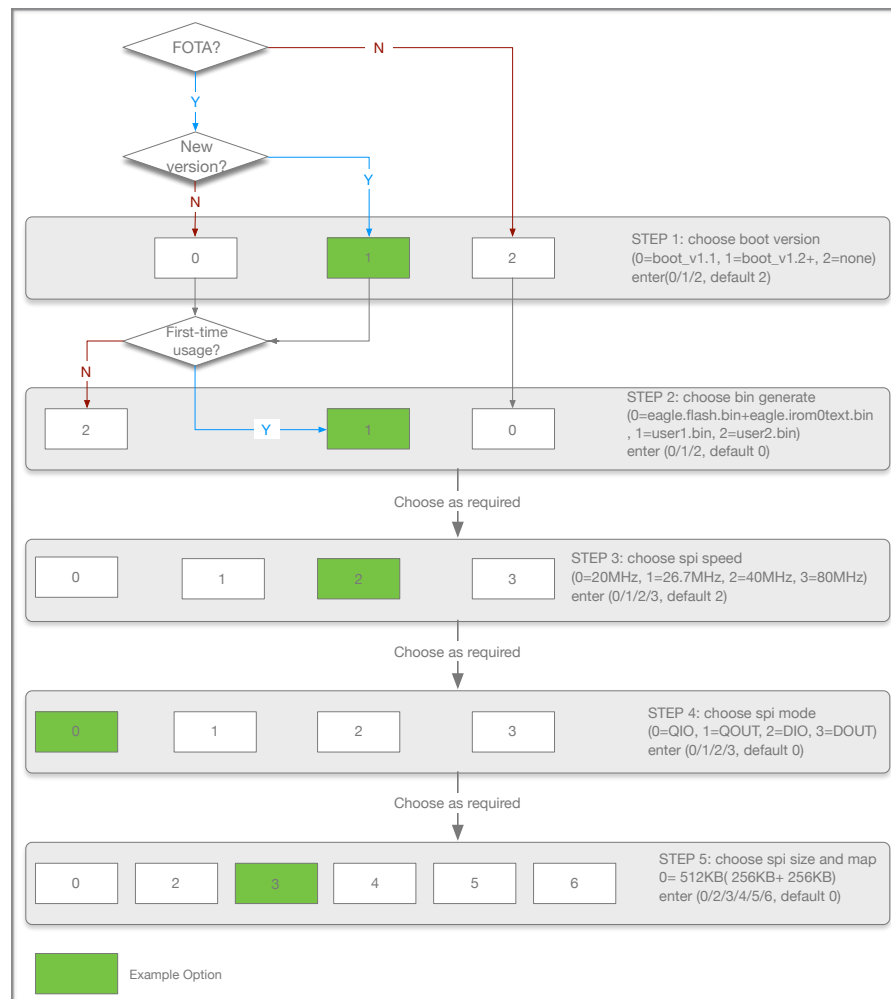

Figure 5-1. Compile SDK

**Notes:**

- The sample options are marked in green. Users can select the right options as needed.
- For OTA and non-OTA firmware, please refer to Section 1.4, "ESP8266 FW".
- Only `sdk_v1.1.0 + boot 1.4 + flash download tool_v1.2` and higher versions support options 5 and 6 in Step 5.
- After compiling **user1.bin**, execute `make clean` first to clear the temporary files generated by the last compilation, and then compile **user2.bin**.
- For the flash map in Step 5, please refer to Chapter 4, "Flash Maps".

3. After compilation, the generated binaries and the addresses in flash are shown as follows:

```
Generate user1.2048.new.3.bin successfully in folder bin/upgrade.  
boot.bin----->0x00000  
user1.2048.new.3.bin--->0xSupport boot_v1.2 and +  
01000  
!!!
```

Note:

Users can open the `/home/esp8266/Share/ESP8266_NONOS_SDK/bin` directory and check the compiled binaries.

-- ←
END

5.2.2. ESP8266_NONOS_SDK_v0.9.4 and Earlier Versions

For ESP8266_NONOS_SDK_v0.9.4 and previous versions, the compilation process is as follows:

1. Execute `./gen_misc_plus.sh 1` to generate **user1.bin** under the `/ESP8266_NONOS_SDK/bin/upgrade` path.
2. Execute `make clean` to clear previous compilation data.
3. Execute `./gen_misc_plus.sh 2` to generate **user2.bin** under the `/ESP8266_NONOS_SDK/bin/upgrade` path.

Note:

ESP8266_NONOS_SDK_v0.7 and earlier are non-OTA firmware.



6. Downloading the Firmware

6.1. Download Procedure

1. Start Windows OS.
2. Double-click **ESP_DOWNLOAD_TOOL.exe** to open Flash tool.

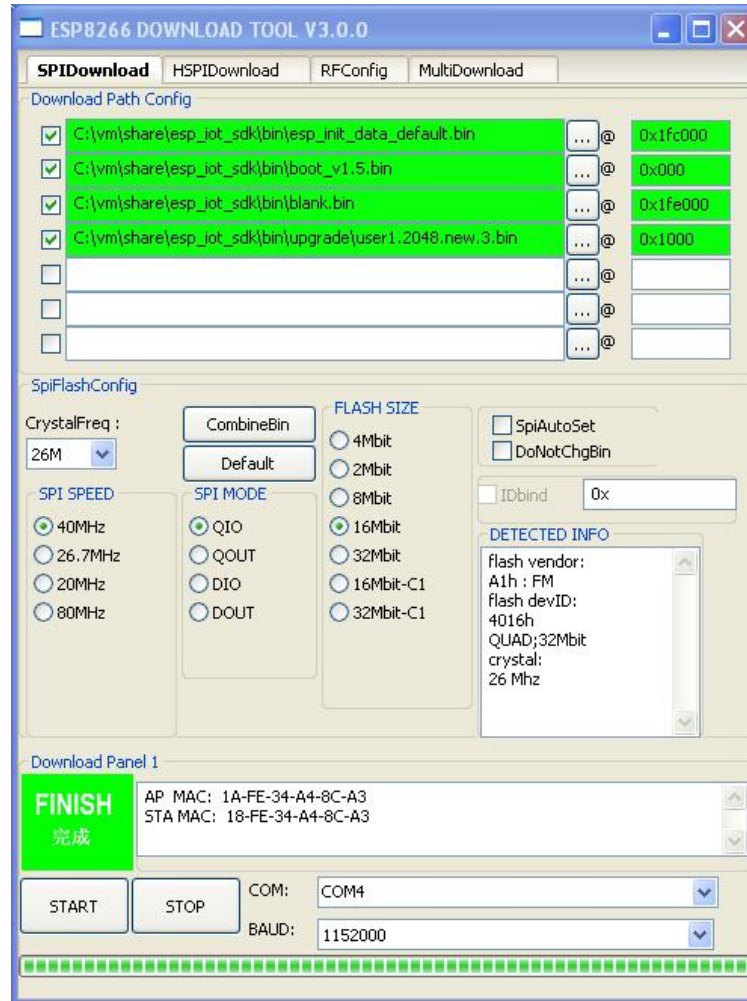



Figure 6-1. ESP8266 DOWNLOAD TOOL – SPIDownload

SPIDownload	For SPI Flash download.
HSPIDownload	For HSPID Flash download.
RFConfig	RF initialization Configuration.
MutiDownload	For multi-mother boards download.



- Double-click  in **Download Path Config** panel to select the binaries to be downloaded. Set the corresponding download addresses in **ADDR**.
- Configure SPIDownload.

Note:

The binaries to be downloaded and the corresponding addresses vary with different SPI Flash sizes and actual demands. For details, please refer to Chapter 4, "Flash Maps".

Table 6-1. SPIDownload Configuration

Items	Description
SPI FLASH CONFIG	
CrystalFreq	Select the crystal frequency according to the crystal oscillator used.
CombineBin	Combine the selected binaries into target.bin with the address 0x0000.
Default	Set the SPI Flash to the default value.
SPI SPEED	Select SPI read/write speed with the maximum value of 80 MHz.
SPI MODE	Select SPI mode according to the SPI Flash used. If the flash is Dual SPI, select DIO or DOUT . If the flash is Quad SPI, select DIO or DOUT . ! Notice: If ISSI Flash is used, please refer to Appendix, "Configure ISSI & MXIC Flash QIO Mode".
FLASH SIZE	Select the flash size according to the flash type. ! Note: 16Mbit-C1 refers to 1024+1024 flash map and 32Mbit-C1 1024+1024 flash map as well.
SpiAutoSet	We recommend not checking SpiAutoSet , but configuring the flash manually as needed. If users select SpiAutoSet , the binaries will be downloaded according to the default flash map. The flash map of 16 Mbit and 32 Mbit will be 512 KByte + 512 KByte.
DoNotChgBin	<ul style="list-style-type: none"> If users select DoNotChgBin, the flash working frequency, mode, and flash map will be based on the configuration when compiling. If users do not select DoNotChgBin, the flash working frequency, mode, and flash map will be defined by the final configuration of the compiler.
Download Panel	
START	Click START to start download. When the download completes, FINISH will appear in the green area on the left.
STOP	Click STOP to stop download.
MAC Address	If download is successful, the system will show the MAC addresses of ESP8266 STA and ESP8266 AP.
COM PORT	Select the actual COM port of ESP8266.



Items	Description
SPI FLASH CONFIG	
BAUDRATE	Select the baud rate of downloading. The default value is 115200.

5. After downloading, turn **GPI00** Control on ESP-LAUNCHER to the outer side and power the board on to enable the working mode.

6.2. Check Log File

After downloading firmware, users can check the log printed in the terminal by using the serial port debug tool.

Users need to configure the settings of the serial port debug tool, as follows:

Table 6-2. Serial Port Debug Tool Configuration

Items	Configuration Description
Protocol	Serial port.
Port number	Set the port number according to the connected device.
Baud rate	The baud rate at which the device is running, related to the crystal oscillator. <ul style="list-style-type: none">• 69120 (24 M crystal oscillator)• 74880 (26 M crystal oscillator)• 115200 (40 M crystal oscillator) The ESP8266 AT example supports the baud rate of 115200 by default. Users cannot modify it. The ESP8266 IOT Demo example supports the baud rate of 74880. Users can modify it.
Data bit	8
Calibration	None.
Flow control	None.

6.2.1. ESP8266 IOT Demo

If users download ESP8266 IOT Demo firmware, the system in working mode will show the initialization information including the SDK version, etc. “Finish” means the firmware works properly.

```
SDK version:X.X.X(e67da894)
IOT VERSION = v1.0.5t45772(a)
reset reason: 0
PWM version: 00000003
mode: sta(18:fe:34:a4:8c:a3) + softAP(1a:fe:34:a4:8c:a3)
```



```
add if0
add if1
dhcp server start:(ip:192.168.4.1,mask:255.255.255.0,gw:192.168.4.1)
bcn 100
finish
```

6.2.2. ESP8266 AT

If users download the ESP8266 AT firmware, or the default firmware in ESP-LAUNCHER or ESP-WROOM-02, the system in working mode will display “Ready” at the end. Input command “AT” in the terminal and the system will return “OK”, which means that the firmware works properly.

Notes:

- The baud rate in AT firmware is configured as 115200 manually, however, the default baud rate of ESP8266 is 74880, due to this discrepancy, the system initialization information will be displayed as mojibake. It is a normal phenomenon as long as the system shows “Ready” at the end.
- For more information on AT commands, please refer to [ESP8266 AT Instruction Set](#).



A. Appendix — Configuring Flash DIO to QIO Mode

⚠ Notice:

Choose DIO or DOUT mode when downloading, otherwise errors may occur. There is no need to modify binaries in DIO or DOUT mode.

For some 2-line flash (for example, the flash manufactured by ISSI or MXIC), users can configure the flash from the DIO mode to the QIO mode by modifying the first two bytes in **blank.bin**, as instructed in Table A-1. When booting up, ESP8266 will check the first two bytes of the **blank.bin** file and switch to the QIO mode automatically if the condition set forth in Table A-1 is met.

```
struct boot_hdr{
    char user_bin:2;    //low_bit
    char boot_status:1;
    char to_qio:1;
    char reverse:4;
    char version:5;    //low bit
    char test_pass_flag:1;
    char test_start_flag:1;
    char enhance_boot_flag:1;
}
```

Table A-1. blank.bin Configuration

Option	Description
Without secondary boot loader	Modify <code>to_qio</code> to 0.
With secondary boot loader	Modify <code>use_bin</code> to 0 and <code>to_qio</code> to 0, as well. Modify <code>version</code> according to the current boot version. Example: If users use the secondary boot_v1.5.bin , please modify the first two bytes FF FF to F4 E5.



B. Appendix – Learning Resources

B.1. Must-Read Documents

- [ESP8266EX Datasheet](#)

Description: This document introduces the specifications of ESP8266EX, including an overview of the features, protocols, technical parameters and applications. It also describes the pin layout, as well as major functional modules integrated in ESP8266EX (CPU, flash and memory, clock, radio, Wi-Fi, and low-power management). Additionally, it provides descriptions of peripheral interfaces integrated on ESP8266EX, lists the electrical data of ESP8266EX and illustrates the package details of ESP8266EX.
- [ESP8266 AT Command Examples](#)

Description: This document introduces some specific examples of how to use Espressif AT commands, including single connection as a TCP client, UDP transmission and transparent transmission, and multiple connection as a TCP server.
- [ESP8266 AT Instruction Set](#)

Description: This document provides lists of AT commands based on ESP8266_NONOS_SDK, including user-defined AT commands, basic AT commands, Wi-Fi AT commands and TCP/IP-related AT commands. It also introduces the downloading of AT firmware into flash.
- [ESP8266 Non-OS SDK API Reference](#)

Description: This document lists ESP8266_NONOS_SDK APIs, provides an overview of ESP8266_NONOS_SDK and introduces the readers to system APIs, TCP/UDP APIs, mesh APIs, application specific APIs, definitions and data structures, and APIs for peripheral interfacing.
- [FAQ](#)

B.2. Must-Have Resources

- [ESP8266 SDKs](#)

Description: This webpage provides links to the latest version of ESP8266 SDK and the older ones.
- [Non-OS Sample Code](#)

Description: This webpage provides the sample code for the commonly used functions.
- [ESP8266 Tools](#)

Description: This webpage provides links to the ESP8266 flash download tools and ESP8266 performance evaluation tools.



- [ESP8266 Certification and Test Guide](#)
- [ESP8266 BBS](#)
- [ESP8266 Resources](#)



Espressif IOT Team
www.espressif.com

Disclaimer and Copyright Notice

Information in this document, including URL references, is subject to change without notice.

THIS DOCUMENT IS PROVIDED AS IS WITH NO WARRANTIES WHATSOEVER, INCLUDING ANY WARRANTY OF MERCHANTABILITY, NON-INFRINGEMENT, FITNESS FOR ANY PARTICULAR PURPOSE, OR ANY WARRANTY OTHERWISE ARISING OUT OF ANY PROPOSAL, SPECIFICATION OR SAMPLE.

All liability, including liability for infringement of any proprietary rights, relating to use of information in this document is disclaimed. No licenses express or implied, by estoppel or otherwise, to any intellectual property rights are granted herein.

The Wi-Fi Alliance Member logo is a trademark of the Wi-Fi Alliance. The Bluetooth logo is a registered trademark of Bluetooth SIG.

All trade names, trademarks and registered trademarks mentioned in this document are property of their respective owners, and are hereby acknowledged.

Copyright © 2020 Espressif Inc. All rights reserved.