

# Pmod ToF Reference Manual

The Digilent Pmod ToF (Time of Flight) is a sensor that enables optical distance sensing at low power. The on-chip digital signal processor of the ISL29501 (<https://digilent.com/reference/lib/exec/fetch.php?tok=f281fe&media=https%3A%2F%2Fwww.renesas.com%2Fcu%2Fen%2Fwww%2Fdoc%2Fdatasheet%2Fisl29501.pdf>) calculates the time it takes for light emitted by the ToF to fly to the target and back, which is proportional to the distance to the target. The Pmod ToF can measure distances of up to five meters.

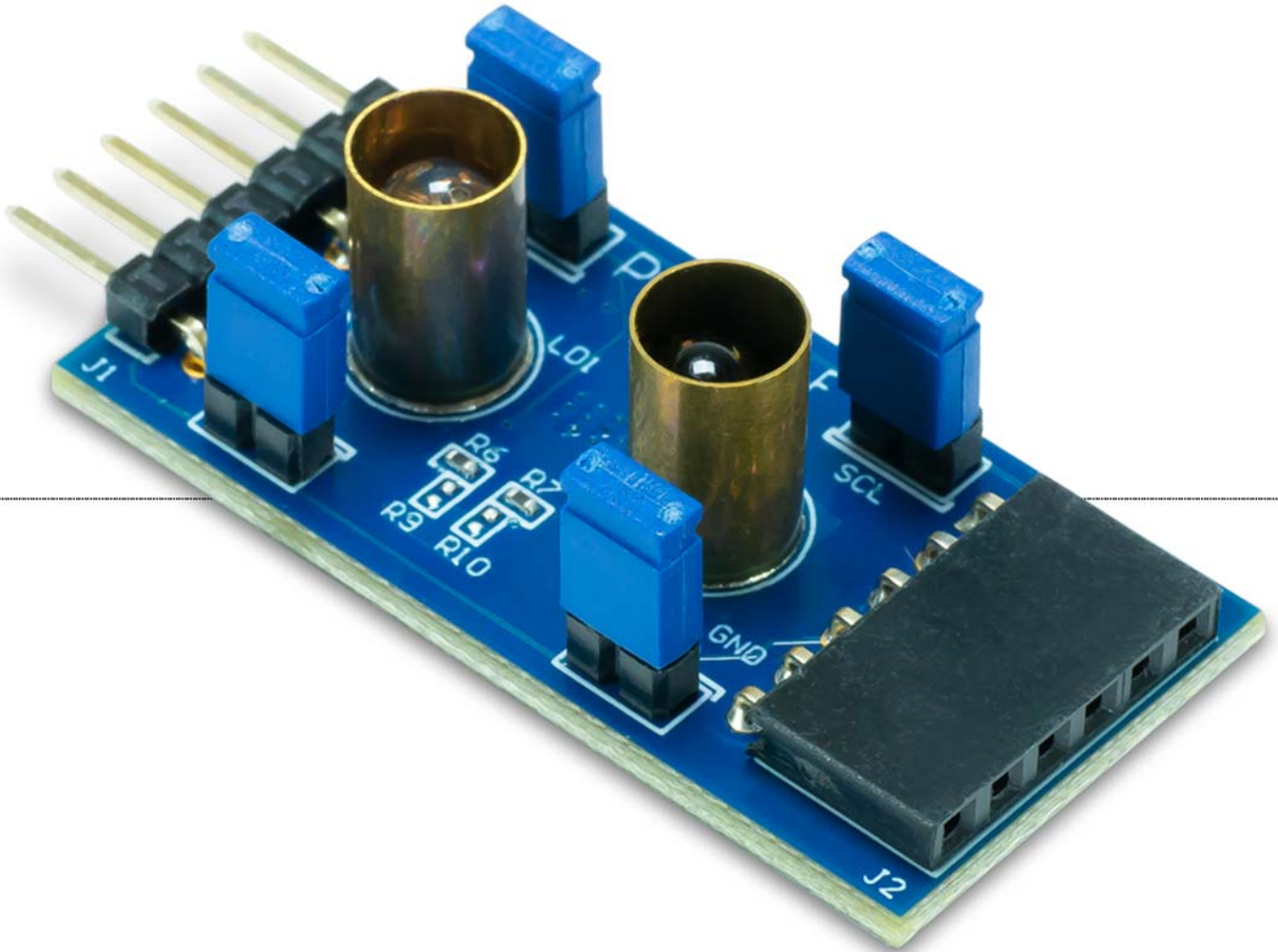

([https://digilent.com/reference/\\_media/reference/pmod/pmodtof/pmodtof-obl-1000.png](https://digilent.com/reference/_media/reference/pmod/pmodtof/pmodtof-obl-1000.png))

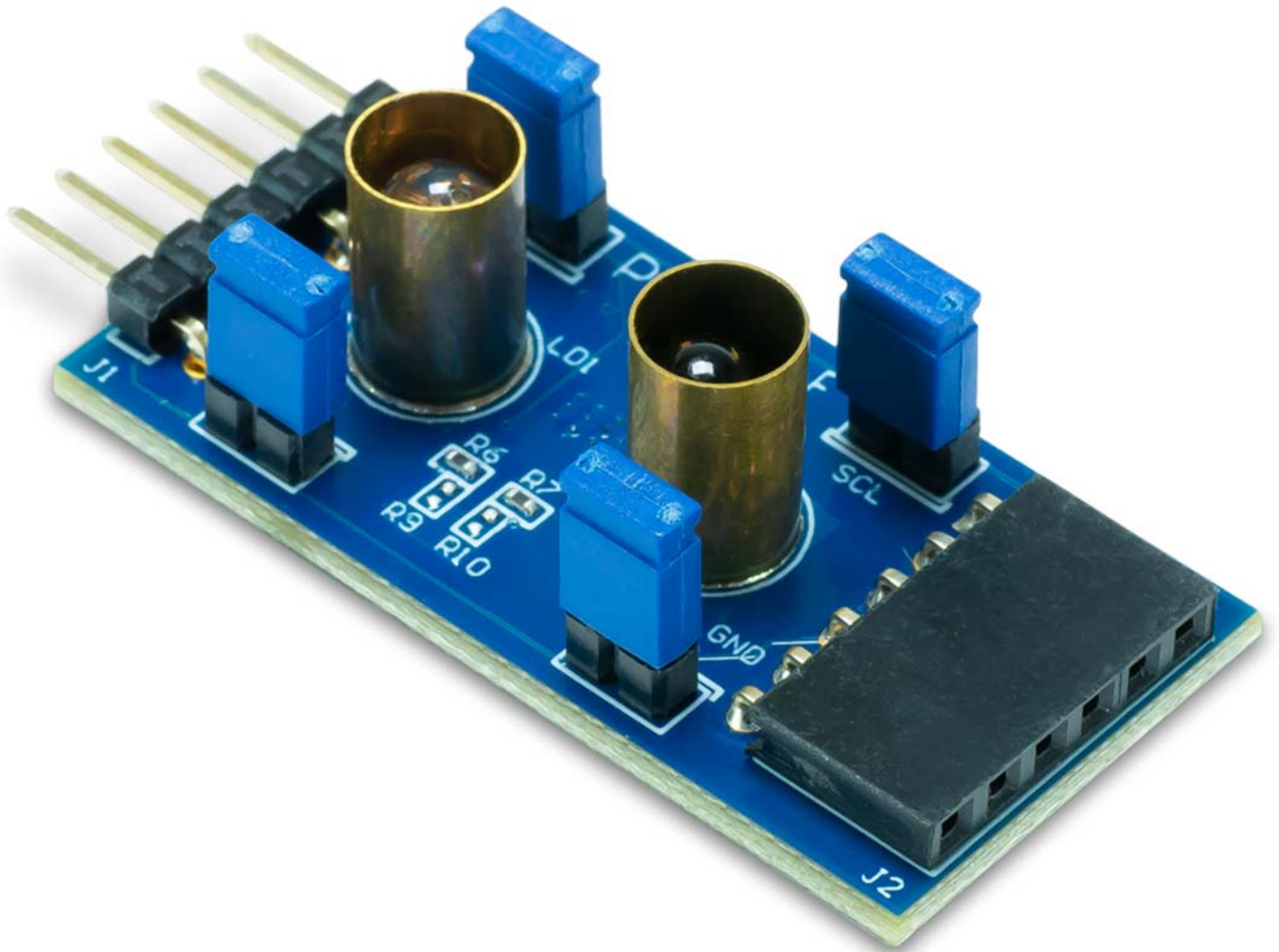

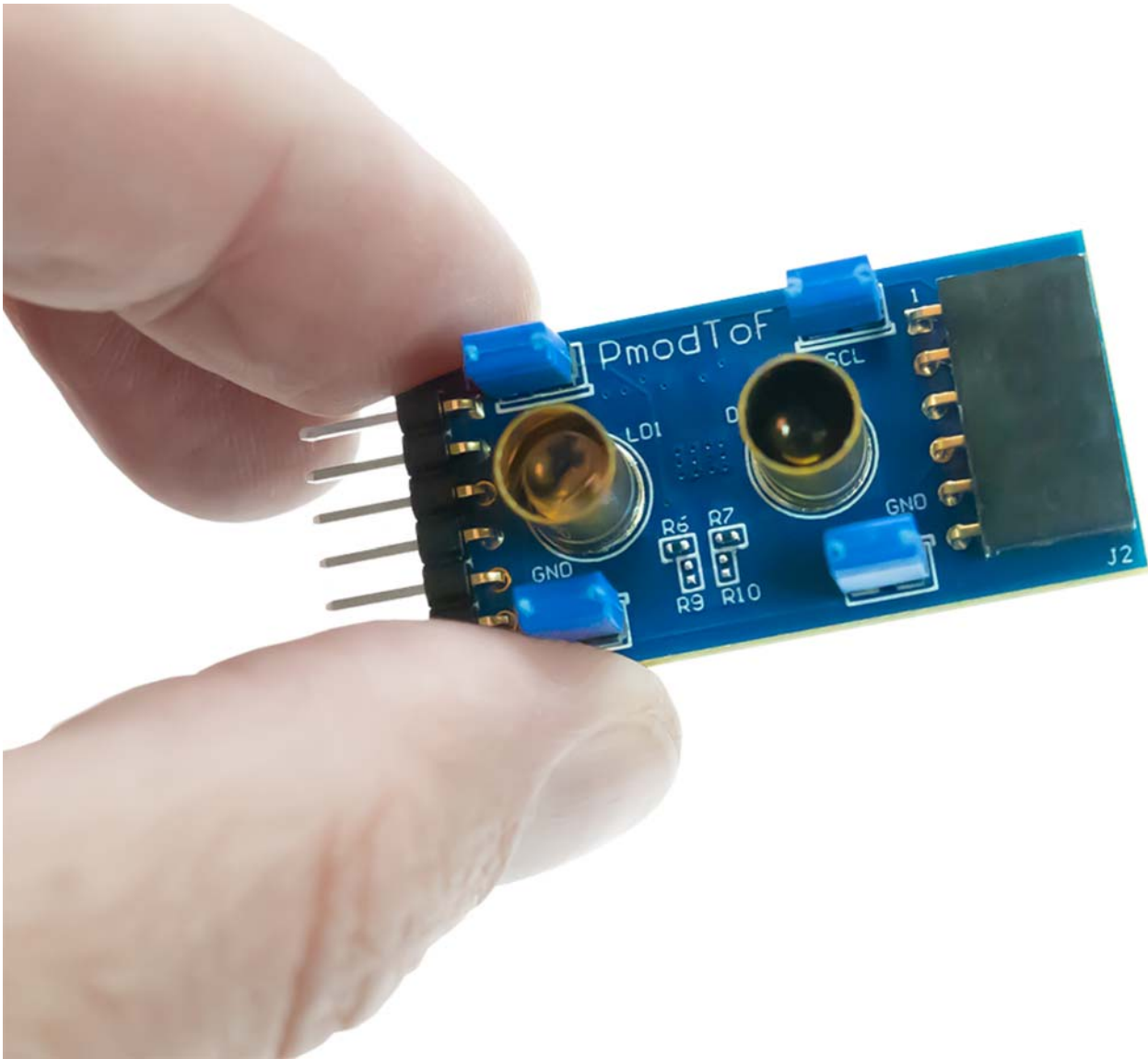

## Features

- Optimized low-power modes
- Enables proximity detection and distance measurement
- 16-bit resolution
- Onboard `EEPROM` to save the calibrations
- 6-pin Pmod connector with I<sup>2</sup>C interface

- Pass-through Pmod host port for daisy chaining

## Functional Description

The Pmod ToF is designed to digitally report the distance measured by the Time of Flight based signal processing integrated circuit. It has up to 16-bits of resolution.

It operates using the principle of Square Wave Modulated Indirect Time of Flight (SWM-ITOF) in the frequency domain and obtains distance measurements from the phase shift. The sensing is done by an external emitter ([LED](#)) and detector (Photodiode)

## Specifications

Parameter	Min	Typical	Max	Units
Power Supply Voltage	2.7		3.3	V
Serial Clock Frequency	10	100	400	<a href="#">kHz</a>
Parameter	Value			Units
Maximum Current Consumed		55		mA
Wavelength		860		nm
Emission angle		+/-3°		

## Interfacing with the Pmod

The Pmod ToF communicates with the host board via the I<sup>2</sup>C protocol ([https://diligent.com/reference/pmod/communication\\_protocols/i2c](https://diligent.com/reference/pmod/communication_protocols/i2c)). By first sending the 7-bit I<sup>2</sup>C address of 01010111 (0x57) and then a read/write bit (high/low logic level, respectively), followed by the register address of interest at a maximum clock frequency of 400 [kHz](#), users can read and write Pmod ToF registers, thus implementing configuration of, calibration of, and reading of measurements from, the Pmod ToF. Header J2 ([https://diligent.com/reference/pmod/pmodtof/start#j2\\_pinout](https://diligent.com/reference/pmod/pmodtof/start#j2_pinout)) on the Pmod ToF is a pass-through for all of the signals present on the main Header J1 ([https://diligent.com/reference/pmod/pmodtof/start#j1\\_pinout](https://diligent.com/reference/pmod/pmodtof/start#j1_pinout)) to allow for the daisy chaining of multiple I<sup>2</sup>C compatible modules.

## Application Register Map

All the registers used in the measurement and/or calibration process are described in the ISL29501 [ISL29501 datasheet](#) (<https://www.renesas.com/eu/en/www/doc/datasheet/isl29501.pdf>).

There is a set of registers used at every chip initialization. The Chip Initialization routine is described in [ISL29501 Firmware Routines \(an1724.pdf\) documentation](#) ([https://www.renesas.com/us/en/www/doc/application-note/an1724.pdf?\\_ga=2.225173722.1727551698.1569238908-634851053.1552119990](https://www.renesas.com/us/en/www/doc/application-note/an1724.pdf?_ga=2.225173722.1727551698.1569238908-634851053.1552119990)).

These values (see table below) are set by Diligent and the user must be very careful changing them. In this situation the user must modify these values before performing manual calibration.

Please read [ISL29501](#) ([https://www.renesas.com/in/en/www/doc/datasheet/isl29501.pdf?\\_ga=2.219327705.1727551698.1569238908-634851053.1552119990](https://www.renesas.com/in/en/www/doc/datasheet/isl29501.pdf?_ga=2.219327705.1727551698.1569238908-634851053.1552119990)) documentation before proceeding.

For more information, consult the [Pmod ToF Library user guide](https://diligent.com/reference/pmod/pmodtof/zynqlibraryuserguide#isl29501_-_time_of_flight_to_f_integrated_circuit) ([https://diligent.com/reference/pmod/pmodtof/zynqlibraryuserguide#isl29501\\_-\\_time\\_of\\_flight\\_to\\_f\\_integrated\\_circuit](https://diligent.com/reference/pmod/pmodtof/zynqlibraryuserguide#isl29501_-_time_of_flight_to_f_integrated_circuit)).

NOTE: Prior to restoring the factory calibration, if the user modified these register values, they must be restored to the values specified below, otherwise the measurements won't be correct.

Register address	Data
0x10	0x04
0x11	0x6E
0x13	0x71
0x18	0x22
0x19	0x22
0x60	0x01
0x90	0x0F
0x91	0xFF

## Calibration and Measurements

In order to perform an accurate distance measurement, the Pmod ToF needs to be calibrated. It contains an [EEPROM](#) where the calibration can be stored. At the factory, the [EEPROM](#) was programmed with a default calibration profile that helps in performing measurements in a range of 30cm-3m. To obtain the best accuracy, a calibration must be performed.

### EEPROM

The Pmod is equipped with a non-volatile [EEPROM](#) memory chip from Atmel: AT24C04D ([datasheet](#) (<http://ww1.microchip.com/downloads/en/devicedoc/atmel-8896e-seeeprom-at24c04d-datasheet.pdf>) available on Microchip website) which has 4-Kbits of available space. The memory can be accessed over the I2C protocol at the address: 0x50h.

The [EEPROM](#) stores two sets of calibration values. The factory calibration set contains the values for the generic calibration performed when the device was manufactured, and cannot be altered. The user calibration set contains the values generated when the user performs their own calibration. Initially the user calibration set is loaded with the factory calibration vales. It can always be restored by copying the factory calibration set.

Section Content	Section Base Address	Size
Serial Number	0x00	16 bytes
User calibration data	0x10	16 bytes
Factory calibration data	0x20	16 bytes
Free Memory		464 bytes

Please consult the Pmod ToF Library User Guide for more information about usage of and communication with the [EEPROM](#) module. For more details about the calibration process, read more in the [Calibration Procedure](#) section below.

### Calibrations

There are three types of calibrations required for Pmod ToF:

1. **Magnitude calibration:** compensates for the emitter current.

2. **Crosstalk calibration:** compensates for electrical crosstalk observed by the photodiode. At close range a large return signal values for crosstalk has a minor impact on distance measurements. At the far end of the distance range, the crosstalk might exceed the signal, adding significant error to measurements. In order to perform this calibration, the receiver or both optics need to be covered with the foam included in the package to make sure there is no return path for the IR signal emitted by the [LED](#). If the optics are not correctly covered, it will result in large errors when measurements are taken.

*NOTE: The foam included in the package might have some deformities due to the cutting process. In order to insure the best calibration please use the flat side of the foam.*

3. **Distance calibration:** compensates for variation in delay of the emitter, photodiode, and the ISL29501 that will change the signal path delay. It will create a coefficient that will be subtracted in each measurement. For this calibration the user must set a predefined distance for which the calibration is performed. A good calibration at 1.5m can result in the ability of the Pmod ToF to measure up to 5 meters with an error of only a few centimeters. The calibrations should be performed at smaller distances (below 1.5m) to avoid distortion and noise that can affect the calibration. In order to perform the distance calibration, a white target (a target with high IR reflective capacity) should be placed at the desired distance from the Pmod ToF. The Pmod should be also placed at least 40cm above the ground or table and no objects should be within the +/-3° area of the optics. The farther the measurement is taken from the ToF, the bigger the area should be.

For more details about the calibration process, see the ISL29501's [Calibration Guide](#) (<https://diligent.com/reference/lib/exe/fetch.php?tok=f06809&media=https%3A%2F%2Fwww.renesas.com%2Fen%2Fwww%2Fdoc%2Fapplication-note%2Fan1983.pdf>).

### Measurements

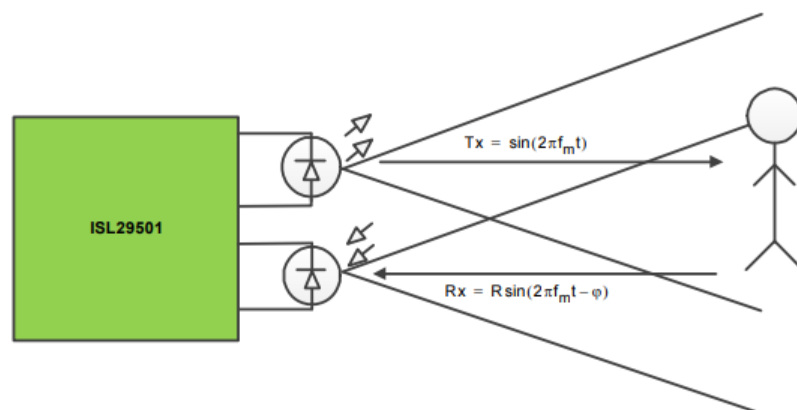

([https://diligent.com/reference/\\_detail/reference/pmod/pmodtof/txrx.png?id=pmod%3Apmodtof%3Areference-manual](https://diligent.com/reference/_detail/reference/pmod/pmodtof/txrx.png?id=pmod%3Apmodtof%3Areference-manual))

A measurement cycle of Pmod ToF is triggered by a falling edge on the sample start (SS) pin, or by the host board issuing a soft\_start to the ISL29501's command register via I2C. When performing a measurement, the chip emitter driver transmits a modulated square wave (Tx) at a given frequency optical signal ( $f_{mod}$ ) through the emitter. The received optical signal (Rx) returns with a phase shift and attenuation depending on the distance and reflectivity of the object it bounced off of. The distance from the object is calculated by determining the phase shift of the return signal as shown below:

$$D = \frac{C}{4 * \pi * f_{mod}} * \Delta\varphi \quad (1)$$

Where:

D is the distance of the object from the sensor.

$f_{mod}$  is the modulation frequency.

$\Delta\varphi$  is the phase difference between the emitted and return signals.  
 C is the speed of light.

### Pinout Table Diagram

Header J1			Header J2			Jumper Blocks		
Pin	Signal	Description	Pin	Signal	Description	Jumper	State	Description
1	IRQ	Interrupt	1	IRQ	Interrupt	JP3	Enabled	communication enabled on IRQ line
2	SS	Sample Start	2	SS	Sample Start	JP4	Enabled	communication enabled on SS line
3	SCL	Serial Clock	3	SCL	Serial Clock	JP1	Enabled	2.2 kΩ resistors enabled on the SCL line
4	SDA	Serial Data	4	SDA	Serial Data	JP2	Enabled	2.2 kΩ resistors enabled on the SDA line
5	<u>GND</u>	Power Supply Ground	5	<u>GND</u>	Power Supply Ground			
6	<u>VCC</u>	Power Supply (3.3V)	6	<u>VCC</u>	Power Supply (3.3V)			

The jumper settings when using the demos are JP1: *Enabled*, JP2: *Enabled*, JP3: *Enabled*, JP4: *Enabled*.

Any external power applied to the Pmod ToF must be within 2.7 V and 3.3 V to ensure that the on-board chips operate correctly; however, it is recommended that Pmod is operated at 3.3 V. The Pmod ToF does not draw more than 225 mA of current.

### Timing Diagram

A sample timing diagram for writing to and reading from the Pmod ToF taken from the ISL29501 datasheet (<https://digilent.com/reference/lib/exe/fetch.php?tok=f281fe&media=https%3A%2F%2Fwww.renesas.com%2Fen%2Fwww%2Fdoc%2Fdatasheet%2Fisl29501.pdf>) are provided below:

Example single-byte write sequence to the Pmod ToF

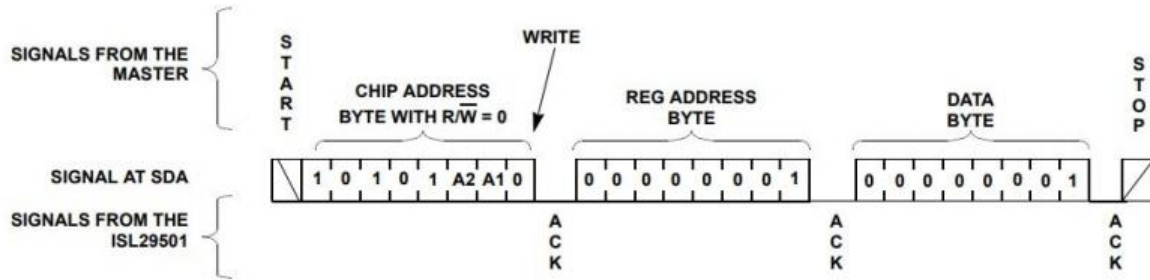

([https://digilent.com/reference/\\_detail/reference/pmod/pmodtof/write.jpg?id=pmod%3Apmodtof%3Areference-manual](https://digilent.com/reference/_detail/reference/pmod/pmodtof/write.jpg?id=pmod%3Apmodtof%3Areference-manual))

Example multi-byte read sequence from the Pmod ToF

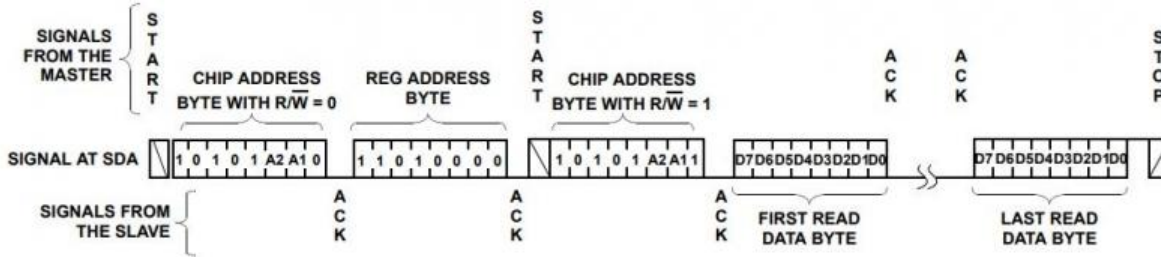

([https://digilent.com/reference/\\_detail/reference/pmod/pmodtof/read.jpg?id=pmod%3Apmodtof%3Areference-manual](https://digilent.com/reference/_detail/reference/pmod/pmodtof/read.jpg?id=pmod%3Apmodtof%3Areference-manual))

### Physical Dimensions

The pins on the pin header are spaced 100 mil apart. The PCB is 1.6 inches long on the sides parallel to the pins on the pin header and 0.8 inches long on the sides perpendicular to the pin header.

### Software Libraries

Digilent provides a Library to access Pmod ToF functionality with Digilent FPGA development boards. The Library can be found in the [Vivado Hierarchies](https://github.com/Digilent/vivado-hierarchies) (<https://github.com/Digilent/vivado-hierarchies>) GitHub repository.

A demo that allows communication with the Pmod ToF through UART is available in this [GitHub Repository](https://github.com/Digilent/ZyboZ7-20-PmodToF-Demo) (<https://github.com/Digilent/ZyboZ7-20-PmodToF-Demo>). Functions such as calibration and measure can be accessed by issuing commands to the demo via a serial terminal application. Check the [Zybo Z7-20 Pmod ToF Demo User Guide](https://digilent.com/reference/pmod/pmodtof/zyboz7-20-pmodtof-demo-user-guide) (<https://digilent.com/reference/pmod/pmodtof/zyboz7-20-pmodtof-demo-user-guide>) for more details.

### Additional Information

The schematics of the Pmod ToF are available here ([https://diligent.com/reference/\\_media/reference/pmod/pmodtof/pmodtof\\_sch.pdf](https://diligent.com/reference/_media/reference/pmod/pmodtof/pmodtof_sch.pdf)). Additional information about the Intersil distance sensor, including communication modes and specific timings of the chip can be found in the “Documentation” area of the ISL29501 product page, found  here (<https://www.renesas.com/eu/en/products/sensors/proximity-sensors/light-to-digital-sensors/device/ISL29501.html#documents>).

Example code and more information on how to use the Pmod ToF can be found on its Resource Center (<https://diligent.com/reference/pmod/pmodtof/start>).

If you have any questions or comments about the Pmod ToF, feel free to post them under the Add-on Boards section of the  Diligent Forum (<https://forum.diligentinc.com/forum/7-add-on-boards/>).

[pmod](https://diligent.com/reference/tag/pmod?do=showtag&tag=pmod) (<https://diligent.com/reference/tag/pmod?do=showtag&tag=pmod>), [pmodtof](https://diligent.com/reference/tag/pmodtof?do=showtag&tag=pmodtof) (<https://diligent.com/reference/tag/pmodtof?do=showtag&tag=pmodtof>), [distance](https://diligent.com/reference/tag/distance?do=showtag&tag=distance) (<https://diligent.com/reference/tag/distance?do=showtag&tag=distance>), [reference-manual](https://diligent.com/reference/tag/reference-manual?do=showtag&tag=reference-manual) (<https://diligent.com/reference/tag/reference-manual?do=showtag&tag=reference-manual>), [doc](https://diligent.com/reference/tag/doc?do=showtag&tag=doc) (<https://diligent.com/reference/tag/doc?do=showtag&tag=doc>)

#### **Company** (<https://diligent.com/company/>)

- [About Us](https://diligent.com/company/#about-diligent) (<https://diligent.com/company/#about-diligent>)
- [FAQs](https://diligent.com/company/#faqs) (<https://diligent.com/company/#faqs>)
- [Shipping & Returns](https://diligent.com/shipping-returns/) (<https://diligent.com/shipping-returns/>)
- [Jobs](https://diligent.com/company/#jobs) (<https://diligent.com/company/#jobs>)
- [Legal & Privacy](https://diligent.com/legal-privacy/) (<https://diligent.com/legal-privacy/>)

#### **News** (<https://diligent.com/news/>)

- [Blog](https://diligent.com/blog/) (<https://diligent.com/blog/>)
- [Newsletter](https://diligent.com/news/#newsletter) (<https://diligent.com/news/#newsletter>)
- [Events](https://diligent.com/news/#events) (<https://diligent.com/news/#events>)

#### **Affiliations** (<https://diligent.com/affiliations/>)

- [List of Distributors](https://diligent.com/affiliations/#distributors) (<https://diligent.com/affiliations/#distributors>)
- [Technology Partners](https://diligent.com/affiliations/#partners) (<https://diligent.com/affiliations/#partners>)

#### **Subscribe to our newsletter**





Get the latest updates on new products and upcoming sales

Submit

#### **Contact Us**

- [Support Channels](https://diligent.com/support/#channels) (<https://diligent.com/support/#channels>)

Diligent  
1300 NE Henley Ct. Suite 3  
Pullman, WA 99163  
United States of America

-  (<http://twitter.com/DiligentInc>)
-  (<http://facebook.com/Diligent>)
-  (<https://www.youtube.com/user/DiligentInc>)
-  (<https://github.com/diligent>)
-  (<https://instagram.com/diligentinc>)
-  (<https://www.linkedin.com/company/1454013>)
-  (<https://www.flickr.com/photos/127815101@N07>)